

THE QUANTUM AND COSMIC CODES OF THE UNIVERSE



Sebahattin Tüzemen

Please be careful
when opening the book!
There might be
Schrödinger's Cat

The Quantum and Cosmic Codes of the Universe

The Quantum and Cosmic Codes of the Universe

By

Sebahattin Tüzemen

Cambridge
Scholars
Publishing



The Quantum and Cosmic Codes of the Universe

By Sebahattin Tüzemen

This book first published 2020

Cambridge Scholars Publishing

Lady Stephenson Library, Newcastle upon Tyne, NE6 2PA, UK

British Library Cataloguing in Publication Data

A catalogue record for this book is available from the British Library

Copyright © 2020 by Sebahattin Tüzemen

All rights for this book reserved. No part of this book may be reproduced, stored in a retrieval system, or transmitted, in any form or by any means, electronic, mechanical, photocopying, recording or otherwise, without the prior permission of the copyright owner.

ISBN (10): 1-5275-4235-1

ISBN (13): 978-1-5275-4235-8

TABLE OF CONTENTS

Preface	vii
CHAPTER ONE	1
INCEPTION OF THE UNIVERSE	
Creation.....	2
Predictions of thermodynamics.....	6
Understanding the expansion.....	9
Signatures of the Big Bang	12
Big anomalies: dark matter and dark energy.....	16
Chronology	18
Possible futures and the end.....	19
CHAPTER TWO	22
“GENERALLY” RELATIVITY	
Everyday relativity: Galileo transformations.....	24
Early observations and thought experiments	26
Special relativity	27
Lorentz transformations.....	30
Geometrical relativity	31
Other consequences of special relativity.....	34
General relativity	37
Gravitational field equations.....	46
Understanding four-dimensional space.....	48
CHAPTER THREE	53
PRINCIPAL PRINCIPLE: UNCERTAINTY	
Fundamental quantum mechanical implications.....	54
Origin and interpretation.....	62
Heisenberg’s microscope.....	65
Quantum confinement.....	66
Tunnelling.....	68
Uncertainty principle in quantum formalism	69
Social analogy.....	70
Semiconductors.....	71
Hidden variables	73
Philosophical implications	73

CHAPTER FOUR	78
FUNDAMENTAL FORCES	
History and ontological implications	79
Elementary particles.....	85
Propagation	90
Interaction of quarks: fundamental interaction	92
Interaction of hadrons: residual and weak interactions	94
Generation of matter and the cosmos.....	95
Couplings	97
CHAPTER FIVE.....	100
QUANTUM FIELDS	
General overview	101
Basic quantum predictions	103
Brief introduction to gauge theory	105
Understanding gauge theory	106
Gauge bosons: force carriers.....	108
CHAPTER SIX.....	110
BASICS OF THE STANDARD MODEL	
Relativistic Lagrangian	111
Heisenberg's uncertainty principle in the standard model	113
Electrons in the standard model	115
Vacuum polarisation effect	117
Higgs mechanism: mass charge	119
Further predictions	122
Overall summary.....	126
CHAPTER SEVEN	127
SOME EXTREME STATES	
Plasma	129
Water.....	132
Superconductivity	134
Superconductivity versus Higgs mechanism	137
Black hole	140
Subject Index.....	145
Table of Physical Constants	154

PREFACE

Physics is one of the most fundamental sciences. Therefore, virtually everyone is interested in it or everyone somehow faces most of the implications of physics in their lives. Physics with its laws, principles, hypotheses, and theories involves a wide range of areas such as astronomy, cosmology, mathematics, biology, chemistry, engineering, agriculture, geology, geography, computation, philosophy, and many more, including its own specific subjects. However, to the general public it is thought to be a very difficult to understand and comprehend sophisticated concept. For this reason, I decided to write this book in such a way that everyone could discover the central theories of physics and realise how the universe is coded and how it works, giving unique examples and explanations. Of course, quantum and cosmic phenomena contemplate and govern nature. Therefore, the book is grounded in these issues, delivering the fundamental concepts of modern physics from the creation of the universe to the present. The appearances of basic principles, laws, and theories such as Heisenberg's uncertainty principle and Einstein's relativity theories are presented in relation to some of the initial events that happened with the inception of the universe. It is intended that the principia are justified using the basic laws of thermodynamics and quantum physics.

The book is written using conceptual concerns, which give an account of ideas rather than complicating matters with facts and numbers. In this sense, I foresee that this book will be a reference and textbook suitable for all levels of physics, astronomy, cosmology, philosophy, and modern sciences from A level to postgraduate level, as well as a book of popular science, assisting readers to embrace these universal ideas.

Over the years of writing this book, I have been helped by my family Ayça, Mert, and Mevsim. I am very grateful to them. My special thanks to Dr. Ö. Çoban who designed some of the figures as well as my son Cemal Mert Tüzemen who created the intelligent charcoal drawings and designs in the book.

S. TÜZEMEN
Erzurum, April 2019

CHAPTER ONE

INCEPTION OF THE UNIVERSE

“God played dice with the universe and created it from nothing.”¹



The photograph above shows Edwin Hubble (1889–1953) making his famous inspections of space. Hubble is undoubtedly one of the most important astronomers of the twentieth century, whose findings were interpreted as the theory of the expansion of the universe after his death. The Hubble Space Telescope was named in his honour. (Photo by Margaret Bourke-White)

¹ The quotation was transcribed from one of Einstein’s famous expressions.

Ever since the dawn of humankind, there has been curiosity about the kind of environment we live in and how the universe was created. This curiosity has probably provided the main source for our present knowledge and science. Today, the combination of Einstein's ideas of the extent of that "heat as substance" with Hubble's observations on the "expanding universe" has led physicists and astronomers to focus on the Big Bang theory, which has been accepted as a scientific consensus in modern cosmology.

The huge heat released by the Big Bang and the various kinds of transformations of that heat from energy to particles or matter during the particular stages of the creation defined the main principles and laws of nature and physics; humans have been trying to understand what it is all about, and will continue to do so for as long as the world remains.

This chapter will begin with present theories on the inception of the universe, underlining the findings of modern astronomy. Together with a chronology, it will explain the seven steps after the Big Bang, the stages of the creation of elementary and sub-atomic particles, and the foundation of today's known baryonic particles and materials that constitute the planets, stars, and galaxies of the whole universe. Furthermore, the origin of universal constants such as the speed of light in a vacuum (c), Planck's constant (h), Planck length (L), and gravitational constant (G) will be explained, to encourage readers to have an opinion on the formation of the present cosmos. It will introduce reasons for why the non-deterministic quantum and cosmic features of the universe, such as the uncertainty principle, occurred. The expansion of the universe with the Hubble parameter will be explained with a simplified model. Finally, possible scenarios about the end of the universe will be delineated, using the possible relations of the second law of thermodynamics and entropy.

Creation

The Big Bang—from the explosion of an ultra-hot and massless point to the condensation of an ultra-cold and ultra-massive point (black hole)—initiated the miraculous expansion of the universe, which took nearly 14 billion years to constitute the present form of the cosmos (see figure 1.1 for the observable universe).² The expansion still continues as discovered by Edwin Hubble's observations in 1929 on red-shifted radiation from some of

² The initiation of the universe with the Big Bang is a scientific consensus; standard cosmology emerges from the entire series of consensuses.

the galaxies. Since then, data are still collected by the satellite telescope named after him, among others.



Figure 1.1. A logarithmic illustration of the observable universe containing many super-clusters (“clustered” towards the edge of the figure due to the logarithmic image) each containing thousands of galaxies; our Milky Way is included in the centre, with a total ordinary baryonic mass of 10^{53} kg, a diameter of nearly 10^{27} m, and an average temperature of 2.7 K.³

The observable universe is a sphere space within the cosmic horizon, centred by the observer on Earth⁴ at present, covering all the ordinary matter that emits or reflects the electromagnetic radiation sensed by presently available instruments. It appears as the electromagnetic signals and images from these species, which have taken time to reach Earth since the beginning of the expanding universe. Observatories located in different parts of the universe would certainly provide different formations of the observable universe, which would probably match the one centred on Earth only in some aspects.

Interestingly, it is thought that the total observable mass (baryonic matter or normal matter) of the universe is even less than 5% of the entire

³ This file is licensed under a Creative Commons license, created by Pablo Carlos Budassi.

⁴ Probably it has the same etymological roots as the word *ard* in Arabic.

universe, and that the remaining 95% is missing and remains a mystery. This will presently be theorised as *dark matter* and *dark energy*, in order to explain certain unexpected behaviours such as the strange activities of galaxies and the accelerating expansion of the universe observed especially since the 1990s, which advanced and modified the basic principles of modern astronomy and cosmology.

Before we look at the details of these unexpected behaviours, let us discuss why we believe that the universe was created in an unexpected, sudden inception and the sequential evolution of a tremendous energy (heat): the Big Bang. Ontologically, heat⁵ is considered as a substance⁶ like a massless gas, which can move in and out of matter. Although this is a classical concept, it is quite a useful tool in terms of understanding how energy is converted to matter, which constituted the present forms of the universe—planets, stars, solar systems, galaxies, galaxy clusters, black holes, and so on—from the thermodynamics point of view. However, further understanding of the creation, of course, requires quantum mechanical concepts and some sophisticated theories such as “gauge theory” and “quantum field theory” (which will be explained in Chapters 5 and 6); pedagogically, the explanations of classical thermodynamics in the next section are more successful in aiding understanding of the creation.

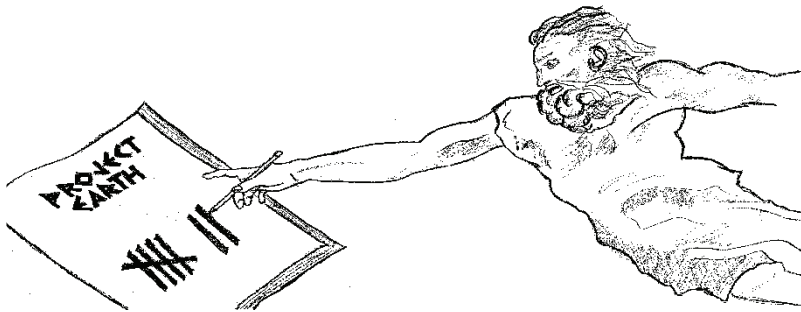

An artist's imagination of creation, visualising the steps of the creation.⁷

⁵ In ancient history, heat as fire was considered to be one of the four basic elements.

⁶ Albert Einstein and Leopold Infeld, *The Evolution of Physics from Early Concepts to Relativity and Quanta*, edited by Walter Isaacson (Simon & Schuster, 2007), 35.

⁷ Sketched by Cemal Mert Tüzemen and courtesy of him created for this book.

Several consequently instigated initial events and conditions have coded and structured the present form of the universe. As the noted Turkish composer Fazıl Say⁸ describes in his famous “Universe” Symphony, “the dark matter is the evidence of the creation of the universe which creates itself out of nothing.” The melody progresses with seven notes, probably pointing out the following seven stages⁹ of the creation:

- (1) The initial expansion caused by the Big Bang lasted only 10^{-36} seconds, called the Planck epoch.
- (2) A sudden exponential expansion called the cosmic inflation¹⁰ occurred within the duration of the inflationary epoch from the end of the Planck epoch to at most 10^{-32} seconds.
- (3) Scale invariant¹¹ quantum fluctuations, which are considered to be due to the cosmic inflation. These fluctuations were like a “butterfly effect,” which structured the present universe, growing from tiny temperature (heat) ripples to, probably, the infinite cosmos.
- (4) Reheating started just after the super-cooling of the universe due to cosmic inflation, populating the universe with a dense and hot mixture of subatomic elementary particles such as quarks, anti-quarks, and gluons constituting the hadrons (protons and neutrons) through electroweak interaction because of the Higgs field, which is explained in Chapter 5.
- (5) Cooling down to average temperatures of 3,000 K due to the normal expansion of the universe.
- (6) Recombination producing small atoms such as helium,¹² hydrogen, deuteron, and lithium.
- (7) Photon decoupling allowing the present observation of red-shifted thermal radiation called *cosmic microwave background radiation* (CMBR).

⁸ Successful globally known composer and pianist.

⁹ Some Asian theologians also indicate the seven-step creation of the universe.

¹⁰ Some sets of very important radio-astronomical observation results by NASA show that the initial phases of the universe are built up with a sudden inflation that happened only 10^{-36} second after the big bang.

¹¹ The fluctuations are scale invariant and brought to the present time with no change, consolidating some of the constants, such as Planck’s, to be constant no matter how big the universe gets.

¹² Helium was somehow produced earlier due to the higher binding energy standing on the higher temperature thermal energies.

Had one of these seven processes happened or occurred in a different way or in a different sequence, then everything in the universe would have been completely different than it is in the present. The universe is so “finely tuned” that the scale of creatures and matter are appropriate to and match each other to constitute the concordance and harmony of everything that conducts an “intelligent system and life.”

Predictions of thermodynamics

In fact, the simple thermodynamic evaluations of the first two of the above-mentioned processes result in an extraordinary understanding of the basic principles and codes of the universe during the creation stages. From the thermodynamical point of view, when the constant Q_i ¹³ amount of heat was created in the Big Bang, because there was no matter at the beginning of the universe, pressure- (p) and volume- (V) dependent mechanical work ($p\Delta V$) was zero, and therefore, the potential¹⁴ energy of the universe is given by

$$U = Q \equiv T_i S_i \quad (1.1)$$

where T_i and S_i are respectively the initial absolute temperature and the entropy of the universe at the time $t=0$. When the universe cooled as it expanded, the entropy had to increase ($\Delta S > 0$) in order to keep the product constant in equation (1.1). This is the second law of thermodynamics, or, as I like to call it, “the first law of the universe.”

Because of cosmic inflation, although the entropy adds up at the macroscopic scale with respect to the second law of thermodynamics, there is a probability of $\pm\delta S$ fluctuations in the entropy at a microscopic scale in a given point of space, when the universe was still microscopic at the beginning of the inflationary epoch. The fluctuations in the entropy were recently confirmed by the fluctuation theorem.¹⁵ These entropy fluctuations resulted in the scale-invariant energy fluctuations of ΔE in Δt amount of time, corresponding to the heat fluctuations according to equation (1.1).

From the quantum mechanical point of view, entropy means the logarithmic number of the quantum (energy) states of a system. Therefore, the fluctuations in the entropy correspond to fluctuations in the number of quantum states. This situation would cause a Gaussian-like distribution of the density of states as $\rho_E = \rho_E(\mathbf{x}, \mathbf{y}, \mathbf{z}, \mathbf{t})$, resulting in an uncertainty in

¹³ Coincidentally, in mystical theology it is believed that the universe was created by God issuing the order *Qun* (Q), meaning “be.”

¹⁴ It is considered that all the energy of the universe started with potential energy, converting itself gradually to other types, such as heat, mechanical, and so on.

¹⁵ D. J. Evans, E. G. D. Cohen, and G. P. Morriss, “Probability of Second Law Violations in Shearing Steady States,” *Phys Rev Lett* 71, no. 15 (1993): 2401.

energy at a given point $(\mathbf{x}, \mathbf{y}, \mathbf{z}, \mathbf{t})$ in space. Later, this will be explained through Heisenberg's uncertainty principle (HUP), which predicts that these energy fluctuations per unit time are quantised¹⁶ with the intervals of the reduced Planck constant, \hbar and given by

$$\Delta E = n\hbar/\Delta t, \quad n = 1, 2, 3, \dots \infty \quad (1.2a)$$

or

$$\Delta E \geq \hbar/\Delta t \quad (1.2b)$$

which I would like to call "the first principle of the universe." It was shown that this principle allows an extraordinary effect, so-called quantum fluctuations¹⁷ in quantum field theory (QFT), which explains the fundamental force fields of mediating particles due to the HUP. Quantum fluctuations caused a sort of butterfly effect, which structured the huge universe from small ripples in the entropy and consequently in the energy.

The decrease in entropy arising from the fluctuations seems to work against the second law of thermodynamics at a microscopic scale. This is to say that the Planck epoch caused a continuous increase in entropy; on the other hand, the latter inflationary epoch caused reductions in entropy, violating the second law of thermodynamics. We can also interpret that the two subsequent events opposed to each other cause an uncertainty in the energy/time or equivalently in the position/momentum couples at a microscopic scale. The violation of the second law of thermodynamics means the violation of the first (conservation of energy)¹⁸ at the microscopic scale, confirming the HUP that bases the standard model of the universe and the QFT, suggesting mediating virtual particles¹⁹ in free space. These unusual extraordinary effects appear only at a microscopic scale and can be ignored at a macroscopic scale, allowing the classic mechanical predictions to be valid for the macroscopic limits of quantum mechanics.

Due to the inflation accompanied by a sudden and huge expansion, the universe was brought to a macroscopic scale (the cosmic scale) from microscopic dimensions. Therefore, T is drastically dropped to a temperature of T_j , more than several orders of magnitudes, resulting in the super cooling of the universe. This decrease in temperature was much higher

¹⁶ Nature gives us quantities (such as energy, charge, and particles) with certain packages of quanta; likewise, an apple tree gives you apples in integer numbers.

¹⁷ The fluctuations appear also in the cosmic microwave background radiation spectrum as a fine structure.

¹⁸ The first law of thermodynamics explains the conservation of energy.

¹⁹ The mediating virtual particles named gauge bosons constitute the fundamental forces.

than the increase in entropy,²⁰ S_f , so that multiplication of the two could not provide the conservation of energy. Therefore, this huge drop in temperature had an earthquake-like effect, compulsorily producing other types of energies (mechanical work and Einstein's equivalent mass energy) in order to compensate for the level of the sudden drop in heat. This caused the creation of elementary particles such as quarks, anti-quarks, and gluons that are the basic constituents of the matter, having pressure (mechanical work) and mass energy. This is the necessity of equation (1.1) with a constant amount of heat incepted in the Big Bang. Therefore, equation (1.1) converts to

$$Q_i = T_i S = T_f S_f + p\Delta V + Mc^2 \quad (1.3)$$

after the creation of the elementary particles with pressure, p , and a total mass²¹ of M (massless ones are not included). In other words, when the heat dropped suddenly, there needed to be mechanical energy (a kinetic term in energy) with pressure and an equivalent mass energy due to the creation of matter, compensating the sudden drop in the amount of heat. This dissipation of heat during the inflationary epoch caused a decrease in the potential energy of the universe as

$$\Delta U = -(p\Delta V + Mc^2) \quad (1.4)$$

Following the cosmic inflation with the super cooling of the universe, the predictions point to a reheating period that further reduced the potential energy, converting to the kinetic energy of the created elementary particles during the inflation as explained in the previous paragraph. Highly energetic particles of the plasma caused super collisions of these elementary particles created during the inflationary epoch, composing (symmetry breaking)²² into the heavy hadrons (protons and neutrons) due to reheating. Due to the ongoing further expansion, this event eventually constituted the small atoms (He, H, and Li) by cooling to appropriate average temperatures of around 3,200 K at which the electronic bonds of the atoms cannot be broken. Since then, it has been possible to convert matter to energy and vice versa either naturally or artificially through nuclear reactions.

There exist some other alternative theories other than the Big Bang within non-standard cosmology. However, the term *non-standard* may change over time by general scientific consensus including a theory or term within standard cosmology. For instance, Einstein's cosmological constant-

²⁰ The increase in entropy is so slow during these stages of the universe that most of the processes can approximately be considered as isentropic ($\Delta S \approx 0$).

²¹ At the beginning just after the Big Bang, the Higgs Field probably didn't exist. As the universe cooled, the Higgs Field existed and gave mass to the particles with whom it interfered. The mechanism is going to be explained later.

²² The term will be further explained in detail in Chapter 5.

Λ was not accepted as standard up to very recent times in the last decade. However, it is now within standard cosmology and has been a backbone of the modern cosmology constituting the *lambda-cold dark matter* (Λ -CDM)²³ model of the universe. After recognition of dark matter and dark energy, the term *hot dark matter* has been removed to outside the standard. Standard cosmology presently recognises that the initiation began with the Big Bang, and that the universe is governed by general relativity, which is explained in Chapter 2.

Understanding the expansion

The most important question arises when we think of an explosion-type of accelerating expansion, which has taken place since the beginning of the universe. The question is, Wouldn't the objects go faster than the speed of light as the acceleration goes on for 14 billion years? Even the relatively small gravitational acceleration of the Earth ($g=9.81 \text{ m/s}^2$) takes a bit less than one year to accelerate a particle to the "pseudo" speed of light.

Conveying the objects to the speed of light is impossible from the relativistic point of view and because we could not have observed the present observable universe since the objects near the edge of the cosmos would go further away from us faster than the speed of light, and, therefore, the cosmic signals could never reach us. For instance, if the galaxies flew apart faster than the speed of light, we could not observe them at the present time.

If we take the expansion as an explosion-type of expansion, we cannot understand the metric growth or metric enlargement of the universe. We should think of spacetime expansion according to general relativity, rather than as only a spatial expansion in a classical explosion-type of expansion. The metric expansion is something that can take place in large-scale species, as at the scale of galaxies. In physics, some anomalies appear when the objects are too small or too big. The quantum phenomena appear at microscopic scales while the metric expansion²⁴ appears at macroscopic scales.

We should think of the metric expansion as the scale growth of the universe rather than the spatial enlargement of the universe. For instance, let us imagine that we wake up to a "Black Monday" situation where the value of money has gone down a million times. The money itself didn't

²³ The standard model of Big Bang cosmology.

²⁴ See for example, A. B. Whiting, "The Expansion of Space: Free Particle Motion and the Cosmological Redshift," *Observatory* 124 (2004).

change, but the scale has changed so that it would cost a million pounds to buy bread or 100 billion pounds to buy a house. We would call this big “inflation,” wouldn’t we? In the inflationary epoch, it is estimated that the universe suddenly expanded nearly 10^{26} times in length in less than 10^{-32} of a second, which is equivalent to an enlargement of a nano-metric distance to about 10^{17} m, and which requires a much higher speed than the speed of light in Newtonian phenomena. An expansion of this kind cannot be explained in terms of classical, ordinary spatial expansion estimations. Although the general expansion of the universe is not that sharp, it is still too big, taking billions and billions of years to reach the speed of light in classical thinking, which is nonsense in modern terms.



The cartoonish imagination of the artist, caricaturing the expansion.²⁵

We can probably understand the expansion with the simplified Minkowski diagram of a light triangle²⁶ shown in figure 1.2. For simplicity, the y and z coordinates are omitted, and the x–t configuration is drawn as a spacetime diagram, only. O represents the observer at reference time t_0 , positioned at the origin, observing the two galaxies situated at points A and B . When the observer measures the distance d_0 between the two galaxies, time for the galaxies will be at the time of t_1 in the past until the light reaches the observer, travelling the green arms of the triangle (AOB). The observer shuts down everything for, let’s say, 10 years and comes back for a new measurement. Time for the observer O' has gone a bit further (10 years) and is now at time t at the bottom of the triangle ($A'O'B'$). In this latter case, light travels the longer red arms, observing the situation of the two galaxies at the time t_2 , since the light travelled the longer length than for the first

²⁵ Sketched by Cemal Mert Tüzemen.

²⁶ For the two dimensions of space, it would be called a “light cone.” It is impossible to demonstrate the three dimensions on a piece of paper.

time. The difference between t_1 and t_2 will be even greater than 10 years, because 10 years is already past for the second measurement and plus the light travelled the longer distances (red lines). This also explains the accelerating expansion because the delay wouldn't be linear if we made a third measurement after 10 more years.

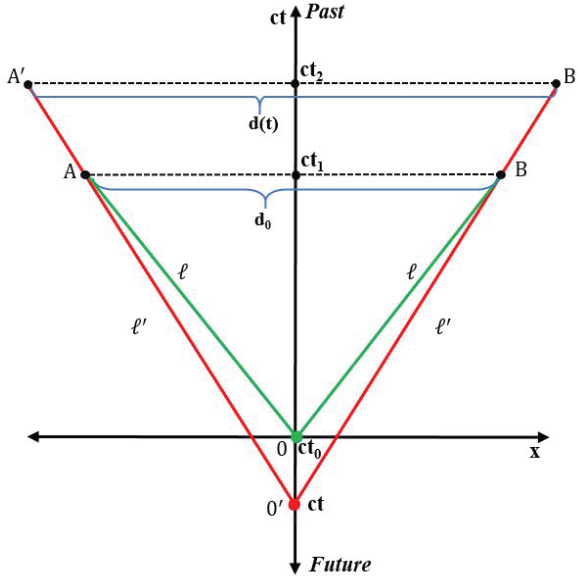

Figure 1.2. A simplified Minkowski diagram imagining a measurement of the distance between the two galaxies (A and B) from the observational point of O .²⁷

In the second measurement, the observer would see the galaxies at positions A' and B' and measure the distance between the galaxies as $d(t)$, which is greater than d_0 due to the light delay. This effect cannot be observed for the objects close to the observer because the light trajectories would be the same between the two subsequent measurements. In fact, the real positions of the galaxies didn't change according to the ones who live in them; instead, we detected the positions of the galaxies much more back in the past, as we went ahead in time. This is really an illusion of spacetime playing a game with us. These illusions are what we have to accept as a reality of the universe at larger scales, which appear according to the spacetime network of general relativity (see Chapter 2). Einstein must have

²⁷ This diagram is exaggeratedly drawn for pedagogical reasons. It cannot be applied to the real situation.

said one of his famous expressions, “Reality is merely an illusion, albeit a very persistent one,” on the basis of these considerations.

The expansion is evaluated by a dimensionless parameter called the scale factor $a(t)$, defined as the ratio of the proper distances between the two specific objects at a given time, t and at a reference time, t_0 ;

$$a(t) \equiv d(t)/d_0 \quad (1.5)$$

Equation (1.5) means that the larger the expansion, the larger the scale factor. The ratio is always ≥ 1 , starting from the reference time as the expansion of the universe continues. It also describes Hubble’s Law, defining the Hubble constant, H given as

$$H \equiv [\partial a(t)/\partial t]/a(t) \quad (1.6)$$

or equivalently as

$$H \equiv [\partial d(t)/\partial t]/d(t) \quad (1.7)$$

This expansion consequently results in the Doppler shift, called the “redshift” in this case, because the observed species goes further away from the observer. The Doppler effect is just like when you hear an ambulance have a sharpening sound as it travels towards you yet have a broadening sound while it travels away from you. The broadening entails the enlargement of the wavelength corresponding to the redshift.

The scale factor can also be defined in terms of the redshift of the observed light wavelength, which is given by

$$a(t) = \lambda_o/\lambda_e \quad (1.8)$$

where λ_o and λ_e are respectively the observed and emitted light wavelengths coming from the observed specimen. Because of the redshift, the ratio is always >1 due to the broadening of the observed light wavelength, as long as the universe expands.

Signatures of the Big Bang

Cosmic Microwave Background Radiation (CMBR) is one of the first signatures of the Big Bang. CMBR is the earliest cosmic code of the universe: it is like the DNA of the cosmos or the fingerprint of the Big Bang left at the “crime scene.” On the other hand, quantum fluctuations are like the “gens” of the universe because they characterised and structured the present universe.

Just as nothing is left secret even if the incident has been over for 14 billion years, a very important hint left from the Big Bang was found by the accidental detection of a parasitic radio frequency (a sort of “cosmic noise”) when the radio astronomers Arno Penzias and Robert Wilson were carrying out a completely different experiment in radio astronomy in 1964. I am not sure whether they were trying to explore the first ever ancient universe

radiation at that time, but they didn't disregard their important observation. The observations eventually resulted in the great discovery of Cosmic Microwave Background Radiation, which is now considered a remnant radiation, emitted from an early form of the universe in Big Bang cosmology. This is probably the most ancient signature of the universe. The CMBR together with the redshift of the cosmic spectra are the fundamental evidence of both the Big Bang and the expansion of the universe.

The scenario is as follows; just after the Big Bang in ultra-hot times, the universe was opaque to photons because all the photons were scattered by plasma. As the expansion took place, the cooling from very high plasmatic temperatures to around 3,000 K gave rise to the coupling of protons (p) and electrons (e) constituting the hydrogen (H) atom. This epoch of the universe is called the recombination era, when the thermal kT energy of around 0.26 eV for $T=3000$ K is not enough to break the p-e bonds of the H atom, which is around 13.6 eV. However, the environment was still hot, and very energetic electrons prefer to drop onto protons emitting the highest possible spectrum of the H atom. This allowed photons to propagate in space rather than being scattered by the plasma, starting an epoch of photon decoupling. However, most of these photons were still absorbed by the matter acting like a black body.

What presently was produced from the thermal radiation of the black body was Cosmic Microwave Background Radiation, which experiences a decrease in energy due to the redshift of the spectrum as the expansion of the universe continues. At the present time, this situation appears to reach us as low microwave energy. Figure 1.3 shows the precise measurement of the spectral distribution of Cosmic Microwave Background Radiation (CMBR) measured by the Cosmic Background Explorer (COBE) telescope of the National Aeronautics and Space Administration (NASA), matching exactly Planck's radiation law at a temperature of 2.7 K.

This is purely black-body thermal radiation of the matter at a colour temperature of around 2.7 K, as described by Planck's Law (see figure 1.3). The colour temperature of the hot gas has dropped from 3,000 to 2.7 K by a factor of roughly a kilo that still increases since the expansion continues.

The simulations from tiny nuanced details of this spectrum show nearly exact resemblances to the Planck radiation of a hot gas that has enlarged to the current size of the universe, despite some fluctuations. These simulations and measurements are unique to the location of Earth where the observations are being made. The results might have been completely different if Earth had been situated in a different galaxy instead of the Milky Way or in a different part of this galaxy.

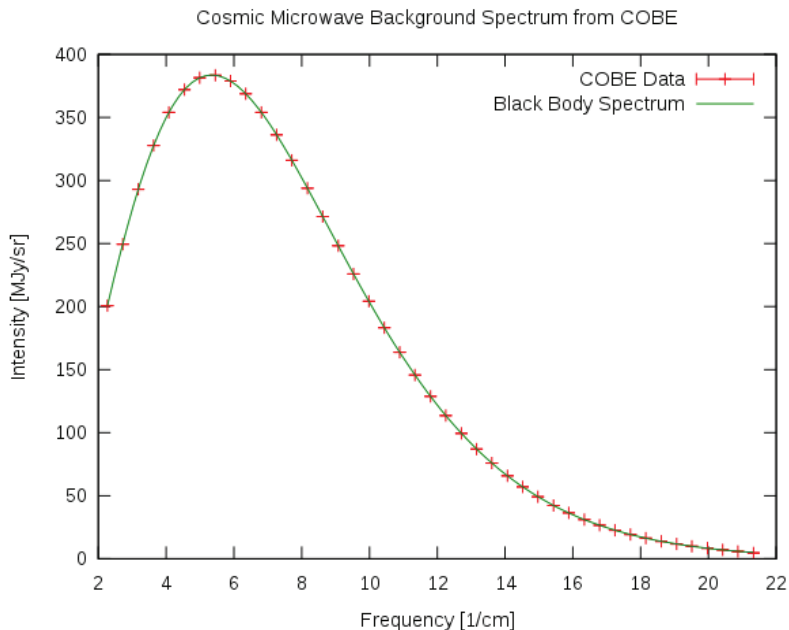

Figure 1.3. Precise measurement of spectral distribution of cosmic microwave background radiation (CMBR) by the Cosmic Background Explorer (COBE) telescope of NASA, matching exactly Planck’s radiation law at a temperature of 2.7 K.²⁸

Quantum fluctuations are also one of the signatures of the Big Bang, which eventually resulted in energy-time or position-momentum uncertainties at a given point in space, and that constituted the fundamental forces and consequently the universe as explained in the creation section. In fact, the entire universe is constituted by two important principia: uncertainty and relativity, which both refuse certainty. In this respect, I would like to point out, paraphrasing Einstein, that these uncertainties are probably a message from the creator, reminding the creatures of the fact that the exact certainty only belongs to Himself and how incapable we creatures are. As Einstein says also, “I want to know God’s thoughts—the rest are mere details.”²⁹

²⁸ Courtesy of NASA, available at <https://lambda.gsfc.nasa.gov/product/cobe>.

²⁹ See http://www.bbc.co.uk/sn/tvradio/programmes/horizon/einstein_symphony_prog_summary.shtml.

Another important signature of the universe is certainly gravitational waves, which were detected recently in 2015, and which should not be mixed up with CMBR. Poincaré predicted gravitational waves in 1905, and Einstein used them in 1916 on the basis of his general relativity theory, presuming that spacetime curvature fluctuates and therefore propagates these waves at the speed of light due to rotation or any kind of motion of the gravitating source. They were only hypothetical until it was directly detected after a century by the US' Laser Interferometer Gravitational-Wave Observatory (LIGO) and the EU's Virgo Collaboration teams observing gravitational waves from a pair of black holes using the advanced detectors of the LIGO and Virgo Interferometers.³⁰ The proof of such waves earned the discoverers the 2017 Nobel Prize. This is also important evidence in terms of differentiating the modern gravitational effect from classical Newtonian gravitation, which predicts instantaneous propagation of physical effects with an infinite speed rather than the speed of light.

The period of these waves is supposed to range from the age of the universe to the orders of milliseconds, depending on whether the source is initiated by certain quantum fluctuations in the early universe or by a rotating supernova. They are not electromagnetic radiation like CMBR but they carry a radiant energy called gravitational radiation. It is also predicted that a background gravitational radiation left from the inflationary epoch ought to exist. However, the predicted energy is so low due also to the redshift that it is under the sensitivity limit of detectors such as the LIGO. Therefore, the background radiation related to the gravitational waves has not yet been detected. The idea of mapping the gravitational waves throughout the observable universe has opened a new gateway to modern astronomy, named gravitational-wave astronomy.

Other significant indicators of the universe appear as physical constants³¹ or universal constants, such as the speed of light in a vacuum (c), Planck's constant (h), Planck length (L), elementary charge (e), electric constant (ϵ_0 —permittivity of free space), magnetic constant (μ_0 —permeability of free space), and gravitational constant (G). All are thought to be signified by the initial conditions of the universe during the Big Bang and thereafter. These scale invariant constants are time independent. This situation eventually constituted a natural mind in the universe extracting a self-governance to have a "fine-tuned" universe, allowing for intelligent life. It is predicted that if these fundamental constants had been slightly different

³⁰ LIGO Scientific Collaboration and Virgo Collaboration, *Physical Review Letters* 116, no. 6 (2016).

³¹ See the table of fundamental constants on the final page of the book.

than they were, this intelligent system of the universe probably would not have existed.

All the other important parameters, such as the fine structure constant (α), the Boltzmann constant (k), the Bohr radius (a_0) or the Rydberg constant (R), are the combinational multiplication and division of the physical constants, which govern the principia and laws of nature. For instance, the Avogadro number (N_A) is an indicator of how much material can be packed in space and is roughly given by the division of a_0 by L . If they were slightly different, N_A would be different and everything in nature would be smaller or larger in size. In fact, the cosmos is a concordance and harmony of matter and energy in the spacetime fabric, which is like a digital art “coded” throughout the universe.

Big anomalies: dark matter and dark energy

First of all, observation of galaxies shows an extraordinary behaviour, which does not even fit the classical Kepler’s Law³² with respect to their visible sizes. According to this law of astrophysics, galaxies with visible sizes should circle a larger orbit if they are flying apart rather than rotating around their centre, as illustrated in figure 1.4. This was a great anomaly, and the explanation of it is rather theoretical, invoking an invisible part called *dark matter*. It means that these galaxies are in fact “obese” even though we observe them as “slim.”



Figure 1.4. An illustration of the dark matter around the rotating Milky Way galaxy. The blue area is the artist’s imagination of the dark matter.³³

³² The law defines the motion of rotating objects in the universe.

³³ Courtesy of the European Southern Observatory (ESO) for press release.

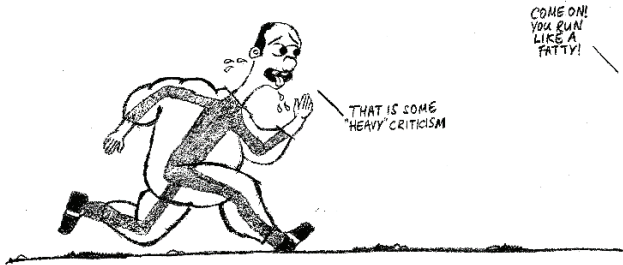

A cartoonish impression of the artist, caricaturing the dark mass.³⁴

It is like watching your favourite athlete, supporting him/her with your cheers, “Run! Run! Run!” but he/she cannot, because he/she is surrounded by some unseen masses that weighs 85% more than he/she normally weighs. This is shown in the artistic charcoal drawing above.

The constituents of the dark matter are presently unknown except that we know what it is not. Anyway, it is not known baryonic or normal matter, because it cannot be detected with presently invented detectors. Modern science predicts and hopes that it can probably be detected through its gravitational effect, such as “gravitational lensing,”³⁵ using presently available techniques.

The total content of the universe consists of nearly 5% ordinary and nearly 27% dark matter, which is 32% of the total. According to the standard model of cosmology, the missing 68% of the total content is another mystery, hypothesised as “dark energy.” The most important evidence that indicates its existence is the accelerating expansion of the universe. It is thought that the universe is a tremendous accelerator. Therefore, a huge force is required³⁶ for such acceleration, corresponding to a massive energy beyond known forms, which is dark energy. Dark energy is so homogeneously distributed across the universe that its density is very low.

Einstein termed the first-known form of dark energy with a constant called *cosmological constant- Λ* , in his general relativity theory, which eventually constituted *Λ CDM (lambda cold dark matter)* or the *lambda-CDM* model of the universe. This was a theoretical requirement in the

³⁴ Sketched by Cemal Mert Tüzemen.

³⁵ According to general relativity, light curves when it crosses a massive object from which emerges gravitational lensing.

³⁶ Some physicists believe it is an unusual form of force other than the four fundamental forces called *the fifth force*.

equations, filling the missing part of the energy. However, after the discovery of expansion it was realised that Λ shouldn't be constant since the observable volume changes over time. Therefore, a dynamic time-dependent scalar field called *quintessence-Q*³⁷ was introduced, although it is very difficult to feel the dynamism of Q to distinguish the difference between Λ and Q in the normal lifetime of the world, since the change is so slow.

Apart from hypothetical predictions such as Λ and Q for dark energy, a more concrete candidate for dark energy is the energy propagated by the "virtual particles"³⁸ that appear due to the HUP in the standard model (see Chapters 5 and 6). However, the calculations of this energy propagated from the annihilation of the virtual particles work out to be extremely high to fit with dark energy; thus, I would rather consider it to be "virtual," leaving the dark energy still as a mystery.

The ratio of the dark energy content of the universe is very high in comparison to the rest. Therefore, the present time of the universe is recognised as the *dark-energy dominated era*.

Chronology

The chronological order of the universe from the Big Bang to the present is given in various different ways such as the cosmic calendar,³⁹ the chronology of epochs or eras, and so on. The cosmic calendar is probably the most famous such chronology in terms of the popularisation of modern astronomy. However, here it is probably better to give it in terms of the eras, since I mention several epochs in this chapter from time to time.

The chronology of the eras during the universe's 14-billion-year adventure can be given as follows (the following is much more comprehensive than the epochs, but still covers the epochs):

1. The very early universe: This era includes the important epochs such as the Planck and the inflationary epochs defining the initial

³⁷ P. Ratra and L. Peebles, "Cosmological Consequences of a Rolling Homogeneous Scalar Field," *Physical Review D*, 37, no. 12 (1988): 3406; R. R. Caldwell, R. Dave, and P. J. Steinhardt, "Cosmological Imprint of an Energy Component with General Equation-of-State," *Phys. Rev. Lett.* 80, no. 8 (1998): 1582–85.

³⁸ Further details of the production of virtual particles will be given in Chapter 5.

³⁹ In this chronology invented by popular astronomer Carl Edward Sagan, a nearly 14-billion-year span of the chronology of the universe is packed into one year from 1 January to 31 December, explaining the events day to day, hour to hour, minute to minute, and second to second. Of this year, we humans came into existence only in the last couple of seconds of the last day of the year.

conditions in the first picosecond of cosmic time. Although some specific laws of physics do not appear in this very early stage, important principles such as Heisenberg's and the tendency of increasing entropy initiated the formation of the large-scale universe.

2. The early universe: Starting from the creation of subatomic particles to the formation of early atoms, it lasted around 377,000 years. Initially, the universe was cold enough to constitute the small nucleuses; the protons and neutrons are composed of without breaking the bonds. However, it was not cold enough to keep the atoms neutral, and opaque plasma didn't release photons to travel long distances. Eventually it was cooled to form neutral atoms and decouple photons to produce the CMBR in the next era.
3. The dark age: This is a very long era lasting from 377,000 years to about 1 billion years. Because recombination and photon decoupling occurred, the photons travelled. However, since there were no stars as light sources, this period is called the dark age of the universe. The only radiation moving around was photons that were released from the H atoms constituting the CMBR that even today is observed as the microwave-radio frequency range. Eventually supernovas, galaxies, and galaxy clusters were formed with the stars in their present forms up to the end of this stage.
4. The present universe: One billion years after the creation, the universe briefly looked as it appears to us today. It will continue to appear very similar for many billions of years into the future. The solar system appeared after about 9.2 billion years and the earliest stages of life on Earth emerged after about 10.3 billion years, around 3.5 billion years ago. The dark energy ratio is so high in this period that it is called the dark energy-dominated era.

Possible futures and the end

The density parameter Ω , representing matter and dark matter densities with M and Λ indexes, respectively, is considered to be an important parameter from which the scale factor in equation (1.5) can be calculated according to Friedmann equations; the distances between galaxies can be estimated according to this parameter, as shown in figure 1.5. If $\Omega > 1$, then the universe is called the *closed universe*, or, the other way around, it is called the *open universe*.

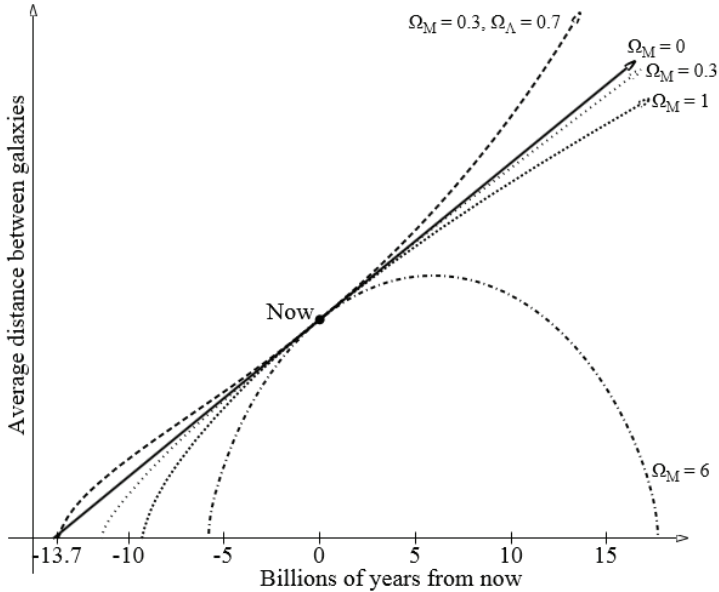

Figure 1.5. Estimated average distance plots as functions of time. The dashed line at the top shows the present expansion of the universe.⁴⁰

Theories estimating the possible ultimate fate of the universe are based on the density parameter being either too low or too high. It is predicted that, from the perspectives of modern cosmology, the present form of the universe will continue for many more billions of years, about 100 billion years from the beginning and about 86 billion years from now. Beyond that all predictions indicate an ultimate destiny, depicting various “doomsday” scenarios.

The “heat death” is a possible scenario: As the expansion of the universe continues, the universe will become consequently colder and less dense. Therefore, eventually everything would collapse into a black hole ending with very slow evaporation due to *Hawking radiation*—the black body radiation emitted from black holes. In other words, the universe would be shutting itself down into “Davy Jones’s locker”⁴¹ forever.

⁴⁰ This work is licensed under a Creative Commons license, which is free to copy, distribute, and transmit.

⁴¹ This phrase means deep down at the bottom of the ocean in sailor’s jargon.

In the “big rip” scenario, as the dark energy content is highly dominated, the acceleration of the universe would rapidly increase to enormous values that the fundamental forces would not overcome; thus there is nothing to keep the masses, atoms, and molecules, and eventually even the nucleuses, together, pulling everything apart, turning everything into their elementary particles. Eventually, even the spacetime fabric would be torn apart.

Although the “big crunch”—proposing the contraction after some point of expansion like a spring—is also another possibility, current observations show that this is unlikely. However, in this scenario, metric expansion of the universe would be reversed into a metric contraction, converting the universe into a hot and dense state at the microscopic scale, returning to the situation at the beginning of the Big Bang.

There are many other scenarios but we shall finish the discussion by indicating that the end of the universe is a requirement in terms of the second law of thermodynamics, proposing an endless increase of entropy. Entropy means “disambiguation”: the increase in this disambiguation, according to the second law of thermodynamics, would bring about the end. It also stems from the ideas of Lord Kelvin, formulated as early as the 1850s.

CHAPTER TWO

“GENERALLY” RELATIVITY

“Time is an illusion.”
—Albert Einstein

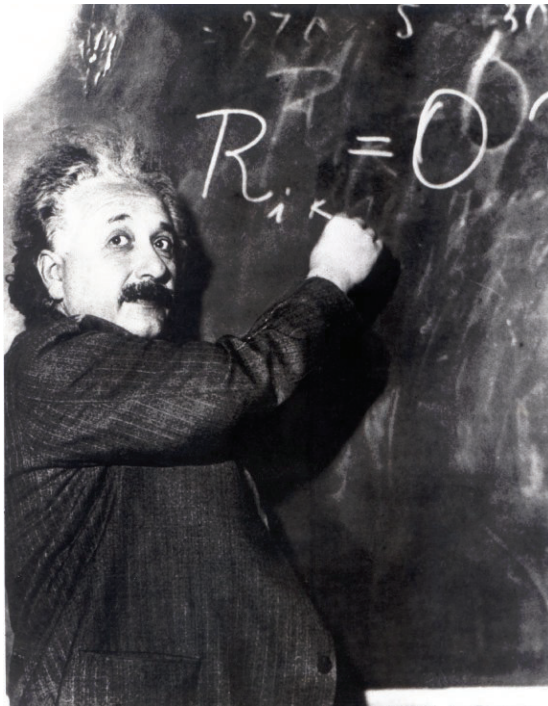

A 1931 photo of Albert Einstein, taken at the Mt. Wilson Observatory Headquarters of the Carnegie Institute in Pasadena, CA, explaining the density of the Milky Way.¹

¹ Supplied by WENN, an internet photograph portal.

From the predictions in Chapter 1, is general relativity a consequence of an expanding universe or vice versa? Let us not answer this, but try to understand why we should compromise with relativity. We certainly know that Galilean relativity started with the three (x, y, z) dimensions and Einstein’s relativity started with time entering as a fourth dimension into space, constituting spacetime. This is because observations cannot be made at infinite speeds due to the restricted speed of light.

Imagine that you are watching a football game (relativistic football) in which the players are as fast as the speed of light or the speed of light is as slow as the players. I am not going to explain what we would or would not see for now; however, it would certainly be a stranger game than we would normally watch in everyday life. Einstein’s relativity theory comes into play when we try to explain these kinds of thought experiments. We shouldn’t omit things just because we cannot witness the physical events in daily life. It would show terrible ignorance of scientists in the modern age.



An interesting conversation between Heisenberg and Einstein from the artist’s eye.²

Let us not forget that light is the natural tool for humankind to observe physical events. The reason why we deny or don’t realise one kind of relativity that Einstein describes in his special and general relativity theories is because the speed of light is much faster than everyday motions. We think we observe things simultaneously at a given instant with infinite speeds.

Nevertheless, we should not underestimate that the speed of light is not infinite, as it has a limited value of around 300,000 km/s, although it is very high in comparison to the speeds we are used to in our daily lives. Therefore,

² Sketched by Cemal Mert Tüzemen.

things get rather strange when the observer or the observed objects reach close to the speed of light. Time would not be as absolute as we think nor as independent of the observer, showing its illusionist artifices to us. This is a relativity that is completely different from the classical Galilean relativity that we feel in position, speed, and acceleration in everyday life when we move or travel at normal speeds. This is a relativity that creates a feeling of change in all basic physical parameters: length, mass, and time, and, consequently, in energy, momentum, and so on.

Intervals of time are classically the same for all the frames of references for a given physical event. However, the absolutism of time is suspended in modern thoughts at speeds close to the speed of light, conceding that it would definitely be dependent on the velocity of the frame of reference or observed species.

In this chapter, we will address relativity in all aspects and simplify things in order to understand the consequences of special and general relativities.

Everyday relativity: Galileo transformations

Before we try to understand Einstein's relativities, let's have a look at how we describe relativity in everyday life, that is, how we describe observations in different frames of references and how they are related to each other. It is a general experience that observers in different frames of reference may measure different positions, velocities, and accelerations for a given object. This is to say that two observers moving relative to each other do not agree on the results of their observations. As an example, consider two observers: one is in a train and the other is at home watching trees outside. The observer in the train would see the trees moving in the opposite direction and the one at home would see them as stationary. We experience this kind of difference in daily life when we travel, when we observe a monkey jumping on a train wagon. Both observers look at the same thing and arrive at different kinds of motions and different values for speeds. All the observers are correct from their perspectives; the difference in their measurements is due to the relative velocity of their frames of reference.

Another example of this is the motion of a parachutist jumping from an aeroplane flying at a constant speed in one direction. An observer on the aeroplane sees the motion of the parachutist as a free fall down toward the ground. However, the stationary observer on the ground sees the trajectory as a parabola just like a projectile motion.

For a general description, consider an object situated at point A in figure 2.1. The motion of this object is being monitored by the two observers: one in the reference frame S, fixed relative to Earth, and the other in the reference frame S', moving to the right relative to S with a constant velocity V_0 . Let us assume that the positions of each observer are at the origins of each reference frame.

The time $t = 0$ is the instant at which the origins of the two reference frames coincide in space. Thus, at time t , the origins of the reference frames will be separated by a distance V_0t . We indicate the position of the particle relative to the S frame with the position vector \mathbf{r} and that relative to the S' frame with the position vector \mathbf{r}' , both at time t .

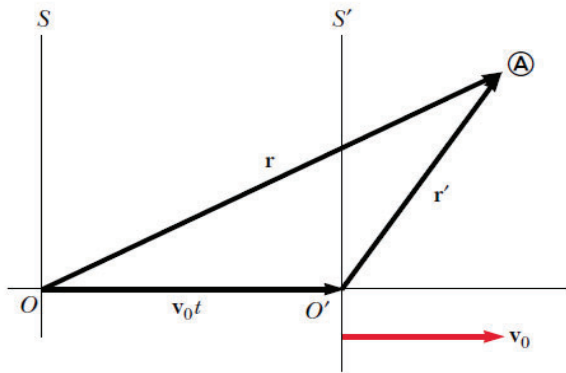

Figure 2.1. Galilean description of an object located at a point of A monitored by the two observers located respectively at O and O', one in the fixed frame of reference S on Earth, and the other in frame S' moving at a constant velocity of V_0 with respect to the stationary frame of S.

As can be extracted from figure 2.1, the vectors \mathbf{r} and \mathbf{r}' are related to each other through the expression given by

$$\mathbf{r}' = \mathbf{r} - \mathbf{V}_0 t \quad (2.1)$$

If we differentiate this equation with respect to time, we find the velocities relative to each other in both reference frames, which can be written as

$$\mathbf{v}' = \mathbf{v} - \mathbf{V}_0 \quad (2.2)$$

Both equations are called Galileo transformations, transforming positions and velocities from the stationary reference frame (S) to the one in motion (S'). The differentiating equation (2.2) gives rise to the fact that accelerations are “invariant” with respect to Galilean transformations in both reference systems. Accelerations would only differ if \mathbf{V}_0 wasn't constant.

Early observations and thought experiments

The Michelson–Morley experiment

In 1887 Michelson and Morley made one of the most important observations towards the development of modern physics by proving that the speed of light is independent of the velocity of the light source, using an interferometer³ named after Michelson. Classically it was thought that there ought to be a slight difference in the speed of light between the light that travels towards ($c + v$) or in opposition to ($c - v$) the rotation of Earth. It is like when an aeroplane flies to the east: the aeroplane moves faster with respect to the ground since the jet stream pushes from behind, or otherwise the ground speed of the craft slightly reduces.

The experimental result of the interferometer designed to prove such phenomenon was rather negative, showing that the speed of light hadn't been affected at all by the direction of the rotation of Earth. This was probably one of the earliest and most important ontological breaks with the classical thought of physics, showing that light does not need any medium (classically named *ether*) to propagate and that the speed of light, c , is an absolute universal constant. There exists another indirect consequence of this experiment that Einstein used, later on, in his special relativity, postulating that “nothing can be faster than light” since the value of ($c + v$) is disproven. The physical reason for this will be explained later when we come to the relationship between mass and energy.

Non-simultaneity

Another important result that brought us to the relativity theories of Einstein is his paradoxical⁴ thought experiment, checking simultaneity. It shows that the coherence of events is only a matter of slow motion or stationary cases in classical Newtonian mechanics. According to Newton, time is an absolute parameter that flies coherently in all frames of references. However, it can be seen that this is not true if we try to understand the following thought experiment, nominally called “Einstein’s train,” proving the relativity of simultaneity.

In this event, a train moves with a speed close to the speed of light on a rainy day. Lightning strikes the front and back of the train wagon simultaneously according to a frame of reference located in the middle of the wagon. However, the event would not be simultaneous to the observer at

³ For the experimental set-up see, for example, R. A. Serway, *Physics—III: Modern Physics* (Saunders College Publishing, 1992), 1107.

⁴ It is paradoxical for classical thought.

the frame of reference watching the wagon from outside the train. According to him or her, lightning would strike the front before the back and the time delay would depend on the speed of the train. This relativity of simultaneity would not be felt with the known speeds that we experience daily. That is why simultaneity is a correct matter in classical physics. However, the train in Einstein’s thought experiment moves so fast ($v \sim c$) that it makes occurrences discrete for the observer watching the train moving with a speed close to the speed of light. This was later recognised as the relativity of time (time dilation) in Einstein’s special relativity refusing the absolutism of time as it appears in the classical physics of Newton.

Big Ben

Another of Einstein’s thought experiments concerns considering what happens if we move away at near light speed from a clock tower like London’s Big Ben while we travel in a relativistic⁵ train. After 10 minutes travel in the train, starting at 10 o’clock, all the clocks in the train would indicate exactly 10 past 10, since they are stationary with respect to the passengers. However, the watch on the tower would not be stationary with respect to the observers in the train and would have lagged a little bit behind. Therefore, the minute hand of the clock could be seen as 1 to 9 minutes past 10 o’clock, depending on how close the speed of the train was to the speed of light, since the light from the tower clock would reach us with a delay. If the train reaches c , then we would see the clock stop at exactly 10 o’clock all the time, that is, time would stop for the people reaching the speed of light. At the normal speeds of a daily train, light would reach us with almost zero delay and we would not feel the relativity of time.

Special relativity

Relativity of time

Another thought experiment involving a train exhibits an extraordinary understanding of special relativity invoked by Einstein in 1905, and helps us formulate the relation between time and speed. Let us imagine that the top ceiling of the wagon is covered by a mirror-like surface and a laser pointer on the floor is shooting at the mirror vertically. If the train is stationary, what we would see from outside the train is that the light beam goes up and down vertically as seen in figure 2.2(a), and, say, Δt_0 amount of time is passed until the beam completes one turn. However, if the train

⁵ Particles or objects moving close to the speed of light are called “relativistic.”

reaches relativistic speeds such as one just short of c moving towards a positive x -direction (right), then we would see the trajectory of light as a triangle from outside, as shown in figure 2.2(b). This is because the train would move $v\Delta t$ amount of the railway until the light hits the mirror and comes back, realising the fact that a further Δt amount of time has to pass until the beam goes up and down. Thus, the time interval for the stationary case is shorter and is longer for the moving ones.

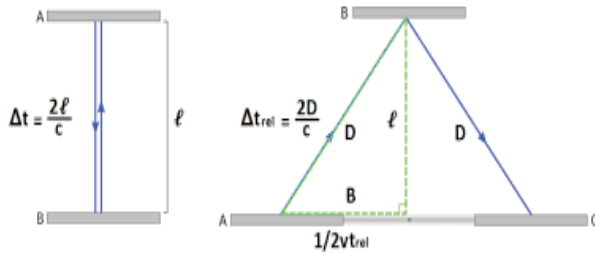

Figure 2.2. Einstein's thought experiment imagining the laser beam (a) in a stationary case (left) and (b) in a relativistic case (right).

Using the geometry of figure 2.2 in a mobile case (right), we can write down

$$\Delta t = \frac{\Delta t_0}{\sqrt{1-v^2/c^2}} = \gamma \Delta t_0 \quad (2.3)$$

where γ is called the Lorentz factor, which is greater than unity since $v < c$. This means that time flows slower for the mobile ones with respect to the stationary ones, that is, any mechanism functions slower when mobile. This phenomenon is sometimes called *time dilation* or *expansion* in relativistic physics. For velocities $v \ll c$, the Lorentz factor approximates unity and we cannot observe any change in time as in the classical case.

These kinds of arguments raise some sorts of paradoxical ideas such as the “twin paradox.” The twin paradox is a thought experiment in special relativity involving identical 20-year-old twin brothers. One of them takes a 60-year journey to space in a high-speed rocket and returns home, finding that the twin who remained on Earth is 80 years old while he is still as young as, say, 30. This result appears puzzling because each twin sees the other twin as moving. Therefore, each should paradoxically find the other to have aged less. However, this scenario can be resolved as follows: the travelling twin has two different inertial frames, one for the outbound journey and one for the inbound journey having acceleration. For this reason, there is no symmetry between the spacetime paths of the twins. Therefore, the twin paradox is not actually a paradox in the sense of a scientific argumentation.

The relativity of time has been experimentally proven using ultra-high accuracy “atomic clocks,” which are more scientifically known as “radio

clocks,” with an accuracy of femto- or even atto-seconds. The clock near the equator works slower than the one near the poles, since the one near the equator moves faster than the one near the poles. The difference is measured to be in the order of nanoseconds per day depending on the position on Earth. Much clearer macroscopic testing of time dilation was carried out by Hafele and Keating in 1977. They loaded portable atomic clocks onboard an aeroplane and flew them several times around the world, measuring the lag of the clocks. The measurements verified the predictions of Einstein’s theory within 10%.

Another test is rather microscopic. It was performed also in 1977 at CERN, measuring the average lifetime of muons for stationary and relativistic situations. The scientists first measured the lifetime of the stationary muons and then accelerated the muons to a speed of $0.9994c$ to measure time dilation. It has been determined by a stationary laboratory clock that the stationary lifetime increased from $2.20 \mu\text{s}$ to as high as $63.5 \mu\text{s}$ in the relativistic case, substantiating exactly equation (2.3).

Relativity of length

Can you imagine an aeroplane getting shorter in size just because it is moving on the runway in front of you? It does if it reaches relativistic velocities; this is called *length contraction*. It is a sort of relativity we never expect for everyday speeds in the classical case. Shortening in length occurs only in the direction of velocity as also illustrated by the artist’s wall painting in the photograph⁶ below.

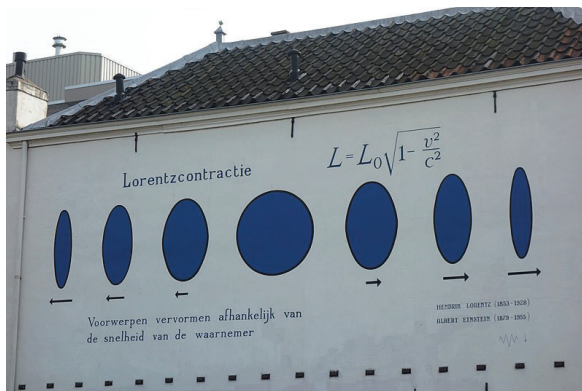

An illustration of the length contraction of the artists’ drawing on the wall of a building in Leiden.

⁶ Courtesy of Vysotsky of Leiden.

To understand the contraction, I shall prefer a straightforward explanation rather than the conventional explanations, which can be occasionally confusing and may, somehow, mislead readers with an idea of an increase in length. Let us say that you are travelling with relativistic speeds in space from planet A (which has a large clock erected on it) to planet B. The trajectory between A and B is a straight line and the velocity is in the same direction. The proper distance between A and B is l_0 according to a stationary observer outside. As you approach B, you would read a shorter period on the clock at A than the stationary observer records, since you fly apart from A with a speed close to light. Therefore, you would think you travelled a shorter distance than the outside observer measured; that is, the distance you measure is given by

$$l = l_0/\gamma \quad (2.4)$$

which is shorter than the proper distance l_0 . The distance intervals you measure outside goes with the velocity of $-\mathbf{v}$ in the opposite direction of the spaceship that you are aboard. Therefore, you measure the intervals as l rather than the stationary observer's l_0 , according to equation (2.4). That is to say, length is contracted due to time dilation.

Lorentz transformations

Lorentz wasn't as dashing as Einstein. Although he formulised all the transforming relativistic equations as early as 1890 from a mobile frame of reference to a stationary one, he did not reach Einstein's level of popularity. Lorentz transformations smartly reduce to Galilean transformations at the limit of low speeds.

Einstein eventually put the transformations into a more generalised context of the *special theory of relativity* (STR), involving some principles and postulates, only 15 years after Lorentz. These transformations are as follows for a stationary frame of reference, $S(x, y, z, t)$, and for a non-stationary frame of reference, $S'(x', y', z', t')$, moving in the positive x-direction:

$$x' = \gamma(x - vt) \quad (2.5a)$$

$$y' = y \quad (2.5b)$$

$$z' = z \quad (2.5c)$$

$$t' = \gamma\left(t - \frac{vx}{c^2}\right) \quad (2.5d)$$

These equations transform positions and times from a stationary frame of reference to one moving with a speed of v in the direction of $+x$, which is close to c . These transformations have an ability to reduce Galileo transformations at everyday speeds, as explained in the first section of this chapter.

You may notice that S and S' report different coordinates as well as times for the same event. The first and second derivatives of these equations

would give the transformations for speeds and accelerations. For a constant velocity, the second term in equation (2.5a) would be cancelled out; where this is the case, the acceleration is said to be “invariant” for the Lorentz transformations or conceptually “Lorentz invariant.”

Geometrical relativity

Starting with the distortion of the circle to ellipsoids by relativistic movement as illustrated in the Leiden photograph in the special relativity section, there should be a definite espousal of the fact that we wouldn’t, in relativistic terms, see the conventional shapes of large objects as we are used to seeing them. If you are watching relativistic football in which the ball has near the speed of light, you might see the ball in a sort of shape that is similar to an American football, as illustrated in figure 2.3.



Figure 2.3. Possible distortions of a ball moving with relativistic speeds perpendicular to the observer’s plane, which is same with a paper plane (reproduced after Kraus).

If a rigid body of any shape moves with a centre of mass velocity of \mathbf{v} , the other parts of the body will be distorted in proportion to the velocity component of each point on the object perpendicular to the observer’s plane.

The Appearance of a Moving Rectangular Grid

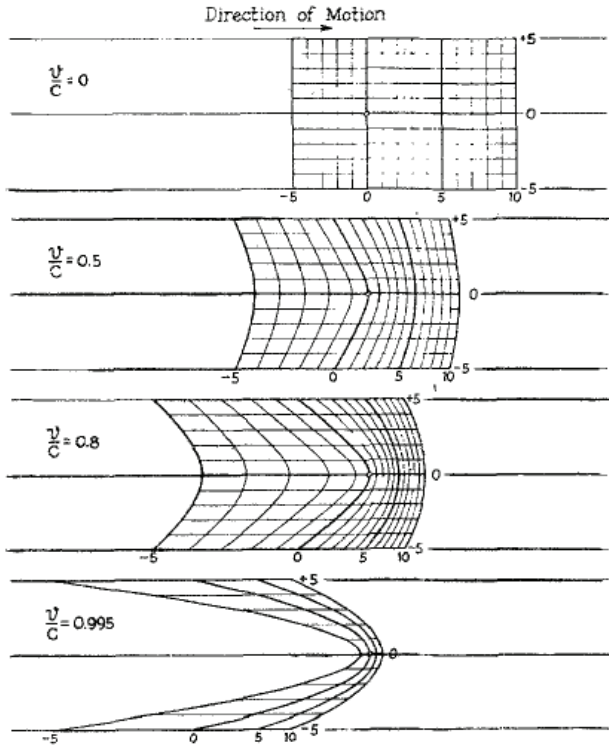

Figure 2.4. Original drawings by Scott and Viner⁷ illustrating how a moving rectangular grid appears at relativistic speeds according to an observer placed at a plane parallel to a paper plane distanced by a unit.

⁷ G. D. Scott and M. R. Viner, "The Geometrical Appearance of Large Objects at Relativistic Speeds," *Am J Phys* 33 (1965): 534.

Appearance of Rectangular Boxes

Observer - 5 units from plane of front surfaces

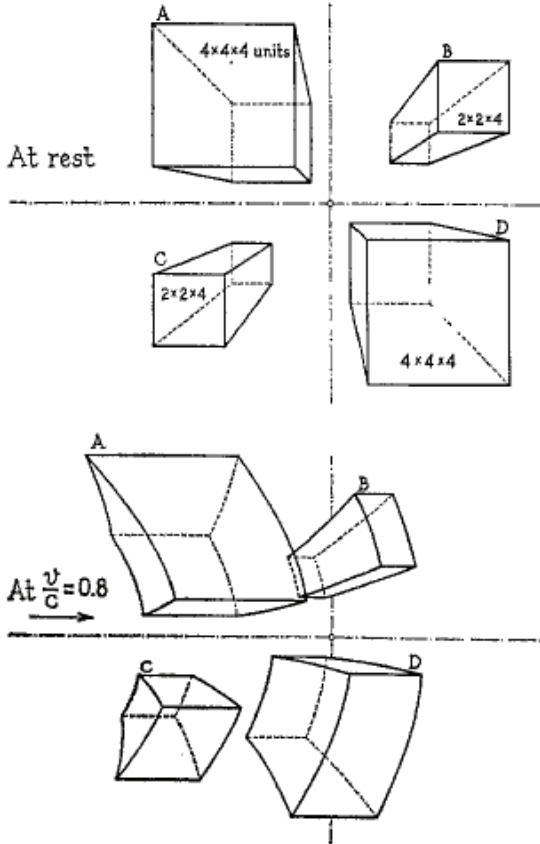

Figure 2.5. Original drawings of the same thing as Ref. 7, illustrating the appearance of rectangular prisms with respect to a stationary observer situated at the origin of the frame of reference distanced five units from the plane of the front surfaces of the boxes.

In this context, figures 2.4 and 2.5 illustrate the distortions of some large objects with respect to a stationary observer produced by computer simulations. Careful analyses of these figures reveal that conventional Euclidian geometry is invalid in relativistic cases.

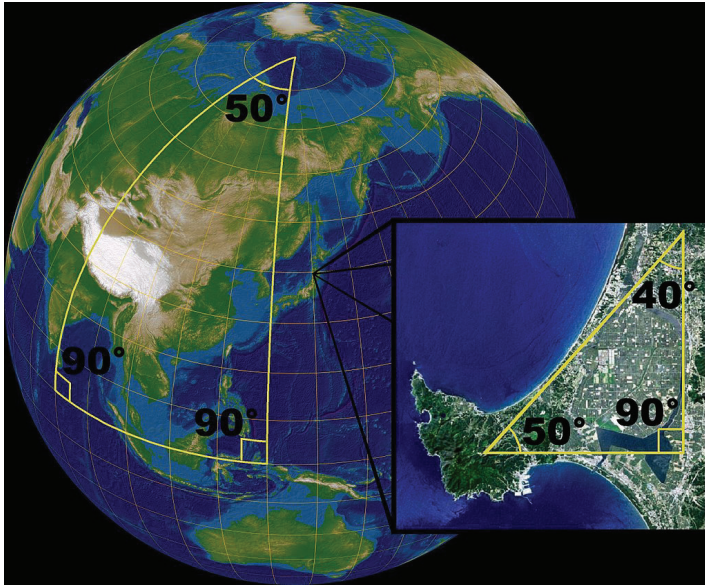

Figure 2.6. A non-Euclidian triangle would be like a triangle on a spherical surface, as shown in the large figure. At short range, the triangle would be the same as the one on a plane surface, as shown in the inset (courtesy of Lars H. Rohwedder licensed under the Creative Commons).

For example, a triangle is unusual if we can observe it on a plane geometry with a total interior angle value of 180° . Triangles would appear like one on a sphere surface with a total interior angle greater than 180° , as illustrated in figure 2.6 in the large-scale map. The inset shows the small scale triangle, which is nearly Euclidian. This will also result in a spacetime bending that will be explained in the “general relativity” section.

Other consequences of special relativity

Relativistic Doppler effect

In Chapter 1, we briefly mentioned the Doppler effect that indicates the frequency or wavelength shifts of waves when the source or the receiver is mobile. In classical cases, for sonic waves that need a medium to transmit, we can express the Doppler phenomena in two separate equations as follows:

$$f = f_0(1 - \beta) \text{ for fixed source and receding detector}$$

and

$f = f_0(1 + \beta)$ for receding source and fixed detector.

We can change the sign of β when the source and detector are moving apart.

It was shown by the Michelson–Morley experiment that the speed of light, c , is independent of the speed of the source. In one of his postulates in the theory of special relativity, Einstein interprets the experiment as the fact that the propagation of light does not require any medium. Therefore, in terms of special relativity, we can write down the Doppler formula for red-shifted frequency with only one equation as follows:

$$f = f_0 \sqrt{(1 - \beta)/(1 + \beta)} \tag{2.6}$$

when the source and the detector are separating, where $\beta = v/c$. For the case of the source and the detector receding, one again just changes sign β , which results in a decrease in the detected signal frequency, f , that would be valid for blue-shifted signals.

For the latter case (blue shift), I have a relatively funny but pragmatic anecdote that we can all learn from. A driver runs a red light and goes to court, declaring that it was green. The clever judge accepts his/her argument but punishes him/her with an “astronomic” and “relativistic” fine for exceeding the speed limit, resolving the case with the decision “in order to see the red light as green you would have needed to have been going a speed of around 50,000 km/h!”

Relativistic mass and momentum

Starting from the contraction of objects when they move with relativistic speeds, we can interpret the fact that they get denser by reducing their volume. This means the atoms or the molecules are bounded with more energy.

Considering where we need the excess negative binding energy, we either give up the conservation of energy or accept that the masses of the relativistic objects are increased. Therefore, we define that the mass of an object having a relativistic velocity of v increases by a factor of the Lorentz factor, γ and write down

$$m \equiv \gamma m_0 \tag{2.7}$$

where m_0 is the rest mass of the object.

We can probably better understand this matter the other way around: Let us say that a moving object has a mass of m resting suddenly and having a mass of m_0 . The negative binding energy comes closer to zero due to expansion, increasing the total energy. This requires a drop in energy corresponding to the drop of the mass of the object at rest.

On the other hand, equation (2.7) also defines the relativistic momentum as

$$\mathbf{p} \equiv m\mathbf{v} = \gamma m_0 \mathbf{v} \tag{2.8}$$

in vector form, confirming also the conservation of momentum in all frames of references. If we described \mathbf{p} with only $m_0\mathbf{v}$, this would not cover up the conservation of momentum for all inertial observers. The equation can be approximated to the classical momentum equation at normal speeds, $v \ll c$.

Relativistic mass and momentum formulas explain another important postulate of the special relativity theory as follows: As the object or particle comes closer to the speed of light (c), γ , and consequently m approach infinity, which makes it impossible to accelerate anymore and limits the relativistic velocities with c ($v < c$), limiting also momentum to reach infinite values that would also be against all the conservation laws of physics. That is to say, nothing can exceed the speed of light. Although some people ectopically invoke particles exceeding the speed of light called “tachyons,” they are all hypothetical.

Considering the angular momentum $\mathbf{L} = m\mathbf{v} \times \mathbf{r}$, mass, m , increases by a factor of γ while \mathbf{r} reduces by the same factor, and \mathbf{L} can be considered as a Lorentz invariant, under rotation. However, the whole “relativistic angular momentum”⁸ is highly complicated and needs tensor analyses.

Relativistic energy

Using the definition of work given by

$$W \equiv \int_{x_1}^{x_2} F dx = \int_0^v \frac{dp}{dv} v dv = K$$

which is done by a force, F , acting only in the direction of x onto an object at rest to start with, increasing its velocity from $0 \rightarrow v$, and also using the relativistic momentum in equation (2.8), we can find the relativistic kinetic energy to be

$$K = m_0c^2(\gamma - 1) \quad (2.9)$$

where $E_0 = m_0c^2$ is the rest energy of the particle independent of the velocity, which is sometimes called *equivalent mass energy*.

The total energy can be written as the summation of the kinetic and potential terms:

$$E = \gamma m_0c^2 = K + m_0c^2 \quad (2.10)$$

where the second term is the potential energy. A very important consequence of relativity is the relation between mass and energy. The equivalence of mass and energy appears in Einstein’s famous equation, $E = m_0c^2$, which is probably the most recognisable physics equation to the person on the street.

⁸ S. Aranoff, “Torque and Angular Momentum on a System at Equilibrium in Special Relativity,” *American Journal of Physics* 37 (1969).

It is important to notice that the relativistic kinetic energy approximates to the classical

$$K = \frac{1}{2}m_0v^2$$

at everyday low speeds ($v \ll c$).

Another important relation between energy and momentum is

$$E^2 = p^2c^2 + (m_0c^2)^2 \tag{2.11}$$

giving rise to the two important results:

$$E = E_0 = m_0c^2 \tag{2.12}$$

when $p = 0$, that is, the rest situation, and

$$E = pc \tag{2.13}$$

when the particles are massless like photons, which attributes a momentum

$$p = h/\lambda \tag{2.14}$$

for electromagnetic waves, confirming the d’Broglie wavelength explained in Chapter 3.

General relativity

I think that we have bogged down this chapter enough with equations, so we shall now try to understand general relativity through letters and philosophy. General relativity is Einstein’s universal perspective on relativity. In special relativity, we considered the consequences of the events when the actors of the events reach relativistic speeds. The consequences appeared as time dilation, length contraction, and so on, due to the fact that light reaches the observer with a delay in relativistic speeds. In general relativity, we will consider the kinds of games that light plays with us when it crosses over large masses in the universe.

The predictions come up with an extraordinary explanation and perspective of gravity that conceptually and ontologically differ from Newton’s classical gravity. Newton sees gravity or gravitation resulting from the force between massive particles or objects, explaining it with the universal law of gravitation, which obeys a reverse-squared equation as a function of distance. Einstein’s perspective is completely different from this concept and gives causal cognitions of it, indicating that gravity is another artifact of light when it passes through a massive object. It is an intuition of the observer because light is affected by the mass as in the case of events with relativistic speeds in special relativity. So how did he imagine that light is affected by mass or how come gravitation occurs?

Einstein imagined a thought experiment, as usual, asking, “what is the equivalent movement that gives the same feeling as gravity?” The answer explains gravity with an extraordinary outcome: spacetime curving.

Equivalence principle

Sit back on a chair as in figure 2.7, close your eyes, feel your weight, and imagine what other kind of physical effect can give you the same feeling. The answer is shown in figure 2.8. Normally, while we are sitting on a chair at home, it is our weight, $W = mg$, that leads us to feel compression on the chair. If you were sitting on the same chair in a rocket moving in empty space with an acceleration that is equal to g ($a = g$), you would feel the same compression on the chair. In the theory of general relativity, it is said that your *gravitational mass* in figure 2.7 is “equivalent” to your *inertial mass* in figure 2.8, and this is postulated as the *equivalence principle*.

We can express this principle in a much more formal way as the *equivalence principle* that is the equivalence of gravitational and inertial mass.

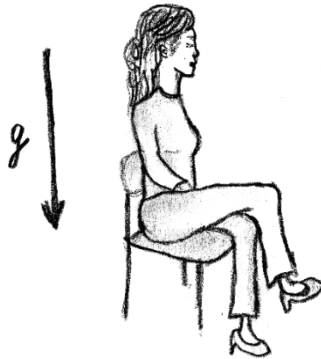

Figure 2.7.⁹ While you sit on a chair on Earth you will feel your weight due to your gravitational mass.

⁹ Charcoal drawing by Cemal Mert Tüzemen.

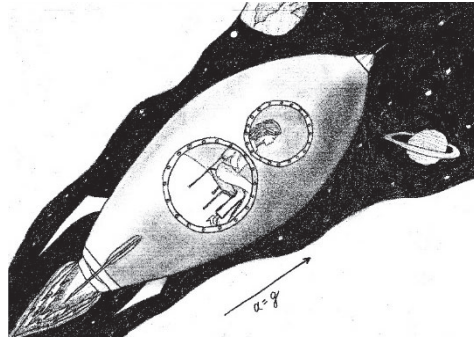

Figure 2.8.¹⁰ You cannot comprehend the difference as to whether you are sitting on a chair in a gravitational field as in figure 2.7 or you are travelling in a rocket with an acceleration of $\mathbf{a} = \mathbf{g}$. According to Einstein’s “equivalency principle,” your inertial mass in this figure is equivalent to your gravitational mass in the previous.

This principle is invoked by Einstein’s thought experiment that the gravitational force experienced locally while staying on a massive body (Earth) is the same as the counter force felt by an observer in an accelerated, *non-inertial frame of reference*.

This is to say that, if you were not allowed to see around, you would not be able to tell whether you were inertial under the effect of gravity, g , or you were non-inertial, travelling in empty space with a constant acceleration equal to g and with no effect from gravity at all. I think the following common saying is apt here: “We’re all passengers on the same road and are going to ride a sign of the Day of Judgement.”

For example, a newborn baby under the effect of gravity would supposedly have the same feeling as accelerating to the speed of light nearly in one lunar year of time (354 days).¹¹ Interestingly, using the value of $g = 9.780 \text{ m/s}^2$ at the sea level of the equator and the precise value of $c = 299,792,458 \text{ m/s}$, this exactly corresponds to 354 days, 18 hours, and 53 minutes, which is only 10 hours 5 minutes more than a lunar period of $T_l = 354 \text{ days, } 8 \text{ hours, and } 48 \text{ minutes}$. This means that we repeat the pseudo-cycle of reaching the speed of light (c) each lunar year. If it is not a coincidence, it is an important universal code of the cosmos or at least of

¹⁰ Same as for footnote 9.

¹¹ One year of the lunar calendar based on the orbit of the Moon around Earth. Each lunar year, we supposedly reach the speed of light according to the equivalent acceleration $a = g$.

the world that $c/g = 1$ lunar year, that is, the ratio of the two important constants gives another important constant. One lunar light year distance would be $L_l = cT_l = gT_l^2$, which is twice the distance of free fall on Earth ($\frac{1}{2} gT_l^2$) for one lunar year.

Now let us return to general relativity and try to understand it through the following section.

Ray bending

Imagine again that you are travelling on a rocket (in a non-inertial frame of reference) as in figure 2.9 and a light beam is incident from the left to the right.

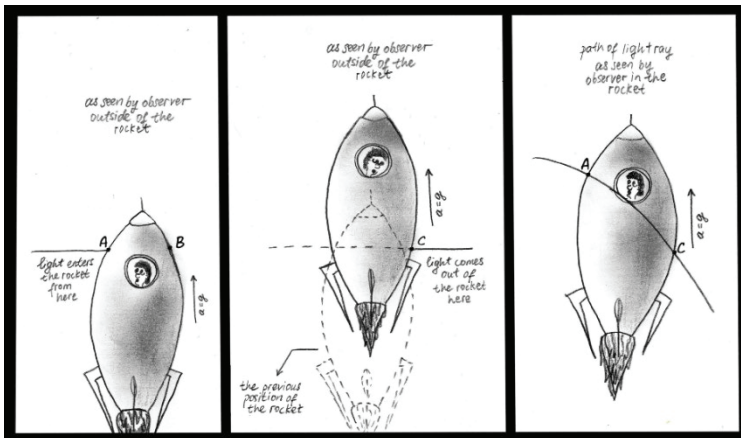

Figure 2.9.¹² An exaggerated illustration of light bending equivalent to gravitational field g .

You would claim that light is entering from A and left from C, not from B, because the speed of light is not infinite and the rocket is lifted up until the beam reaches from A in the left to C in the right; that is, you can argue that the light beam is bent.

On the other hand, an outsider looking in would say that you are wrong, the light beam isn't bent at all, it was moving straight from A to B but the rocket is a little bit lifted and the beam hit to C. You are said to be at the non-inertial frame of reference and the light beam is bent, according to you. In the final context, the external observer is said to be at the inertial frame

¹² Charcoal drawing by Cemal Mert Tüzemen.

of reference and the light beam is passed straightaway according to him/her. As shown in figure 2.10, this would actually cause a time difference between the two observers at respectively non-inertial and inertial frames of references, as in the case of special relativity.

Reconsidering the “equivalence” of the two situations in figures 2.7 and 2.8, Einstein argues in his theory of general relativity that light beams experience the same thing, that is, they are bent in gravitational fields according to the equivalence principle explained earlier. Therefore, he theorises that time is different for the ones under the effect of gravity and for the ones in free space. Time dilation happens for the ones in gravity as shown in figure 2.10, that is, the clock works slower in the gravitational field than in free space.

The fact that light bends in gravity causes a spacetime curvature around the heavy objects of the universe, as shown in figure 2.11 that is drawn for only the $x - t$ space. The curvature, of course, depends on the mass of the object. Therefore, the second derivative of space (x) as a function of time ($a = (\partial^2 x / \partial t^2)$) would be non-zero, giving rise to the gravitational field g that is equivalent to a . The second derivative would approach infinity at the centre of the mass and to zero at distances far from the mass. The curvature would be sharper around heavy objects and we would get greater a corresponding to higher gravitational fields.

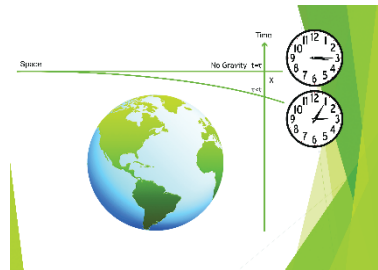

Figure 2.10. An exaggerated and simple illustration of *general relativity observations* of the light ray (green line above) having no gravitational effect and the light ray (bent green line below) under the effect of gravity (Earth) resulting in different timing¹³ by an observer at x .

¹³ The 10-minute delay shown in the figure is just an exaggeration for pedagogical concerns. Normally this time delay for a planet having a mass close to Earth’s is probably in the order of picoseconds, which isn’t normally sensed in daily life.

The curvature would be broader (flatter) around light objects and we would get lower a corresponding to lower gravitations. As can be seen in figure 2.11, as you go further away from the object the curvature flattens and a approaches to zero, which also explains the inverse-square law of Newton. As can be understood from the discussions here, gravity is a perception that is felt relatively due to the bending of light as it crosses massive bodies.

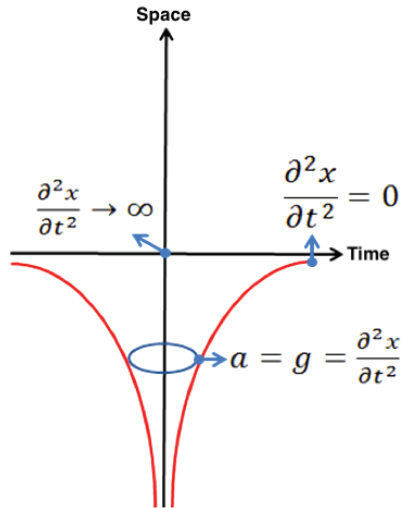

Figure 2.11. Spacetime bending illustrated for only the x - t space, demonstrating how the curvature corresponds to an acceleration and therefore a gravitational field.

You can argue that light bending would also occur for the rocket moving with constant velocity, there is no need to have acceleration “equivalent” to gravity. This is true of the fact that general relativity reduces to special relativity, which is only the effect that is felt due to the speed. General relativity is a phenomenon that occurs due to acceleration corresponding to gravity.

In the case of special relativity (i.e., $v = \text{constant}$), light beams would be bent diagonally without curvature. In this case, spacetime would be expressed by a conical surface called the *light cone* for which a second derivative of space, as a function of time, would be zero, meaning there would be no gravitational effect at all.

It is a reality that the clocks are lidded in gravitational fields, which is proven by atomic clocks as well. In fact clocks on satellites work faster than

on Earth, due to less gravity than on the ground, and internet time is always adjusted with respect to this time difference.

Evidence for light bending

The experiments that proved light-bending date back as early as 29 May 1919, on which day a total eclipse occurred.¹⁴ The observations were recorded as in figure 2.12, showing the slight bending of starlight by the Sun during a solar eclipse. The observation shown in figure 2.12 was a really extraordinary observation by Dyson et al., who predicted that it could not have been a refraction effect around the Sun for the following reasons, using exactly their own words in ref. 14: “It seems clear that the effect here found must be attributed to the sun’s gravitational field and not, for example, to refraction by coronal matter. In order to produce the observed effect by refraction, the sun must be surrounded by material of refractive index $1 + 0.00000414/r$, where r is the distance from the centre in terms of the sun’s radius. At a height of one radius above the surface the necessary refractive index 1.00000212 corresponds to that of air at 1/140 atmosphere, hydrogen at 1/60 atmosphere, or helium at 1/20 atmospheric pressure. Clearly a density of this order is out of the question.”

¹⁴ F. W. Dyson, A. S. Eddington, and C. Davidson, “A Determination of the Deflection of Light by the Sun’s Gravitational Field, from Observations Made at the Total Eclipse of May 29, 1919,” *Philosophical Transactions of the Royal Society of London*, Series A (1920): 291–333.

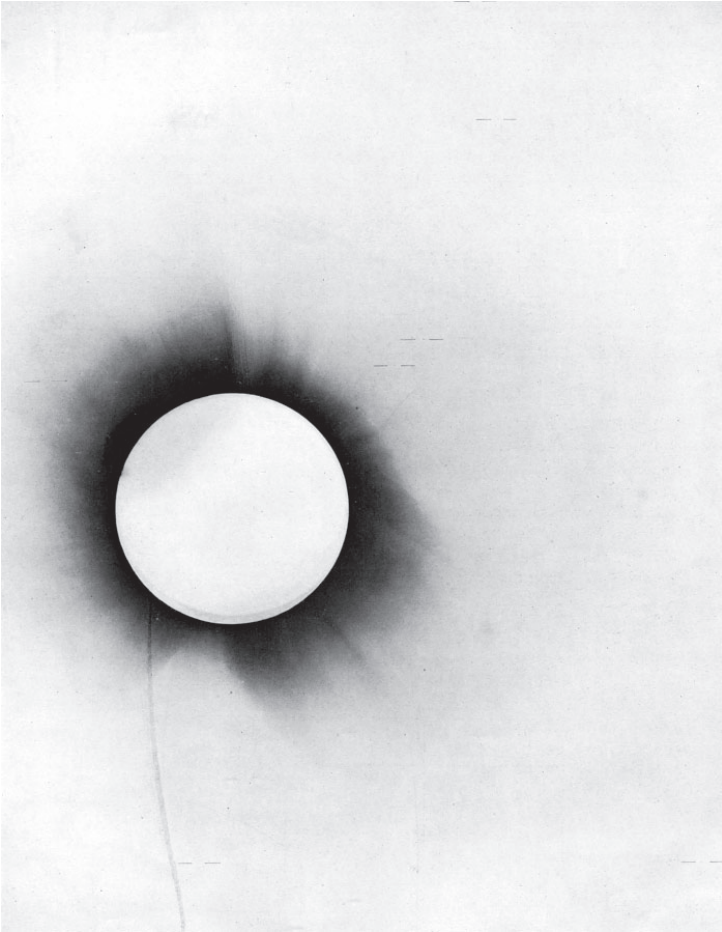

Figure 2.12. First observation of gravitational light bending, illustrating the slight bending of starlight by the Sun during the solar eclipse.¹⁵

¹⁵ Downloaded from <http://rsta.royalsocietypublishing.org/> on 14 November 2018.

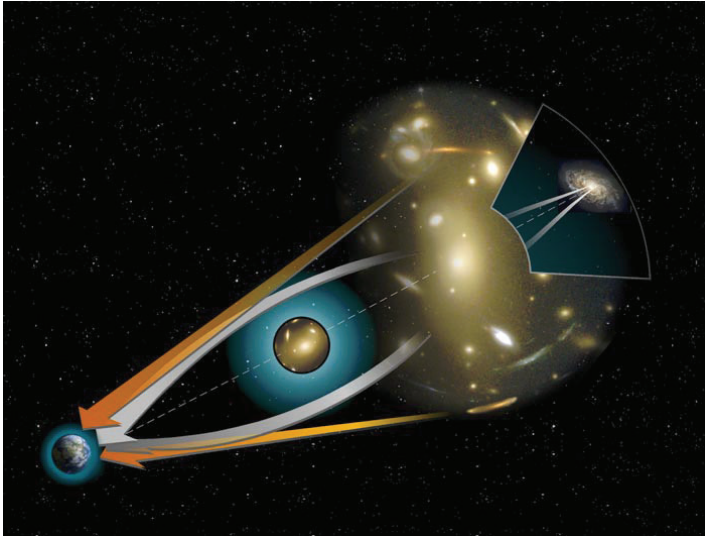

Figure 2.13. Gravitational lensing observed by much more sophisticated telescopes such as the Hubble Telescope, through which you can observe the distant light sources behind the big objects.¹⁶

This supports a kind of beam-bending described in Einstein’s equivalence principle, resulting in the theory of general relativity. This was verified by other observations such as gravitational lensing, which has been observed by more sophisticated telescopes such as the Hubble Space Telescope, as seen in figure 2.13. Bending light around a massive object from distant sources (stars for instance) exhibits a kind of focalisation effect, making allowances for the observations of stars behind heavy objects. This is direct evidence for gravitational lensing as a consequence of light bending around heavy objects in space.

One of the consequences of Einstein’s theory is that there is no possible physical test other than light beams representing geometrical lines. As we expressed in the section of special relativity, Einstein’s theory of general relativity also shows that the true geometry of spacetime is not Euclidian. For example, if a triangle is constructed out of three light beams, then the interior angles of the beam triangle do not add up to 180 degrees due to gravity in general relativity.

¹⁶ Released in the public domain, solely created by NASA.

Before today's sophisticated technology, there weren't gadgets capable of distinguishing deviations from Euclidian geometry. Einstein predicted in his theory that such deviations would exist without using any equipment. As a consequence of his considerations together with the observational proofs, it is now technically recognised that an important component of the correcting software programs that run the Global Positioning System (GPS) have to be installed, using a metric that is not Euclidian, in order to position the images in the correct way.

Classically, you might incorrectly argue that the energy or mass of light is subject to the effect of gravitation in the same way as ordinary matter is, according to Newtonian law. However, this is not true of the fact that a photon is a quantum particle with zero mass. Also the theory of special relativity predicts that, if something has mass, it would be infinite at c , and that is impossible. This is really a game of light bending felt in the way that Einstein describes in the equivalence principle.

Gravitational field equations

Einstein postulated that such phenomena described in the theory of general relativity require a perception of gravity around a massive object in the universe, giving rise to Einstein's law of gravitation that is different from Newton's gravitational law. As described in Chapter 1, Einstein's law of gravitation introduces a cosmological constant, Λ , which is now recognised by cosmologists as a necessary constant explaining the missing part of the energy called dark energy in the lambda-cold dark matter model (Λ -CDM) of modern cosmology.

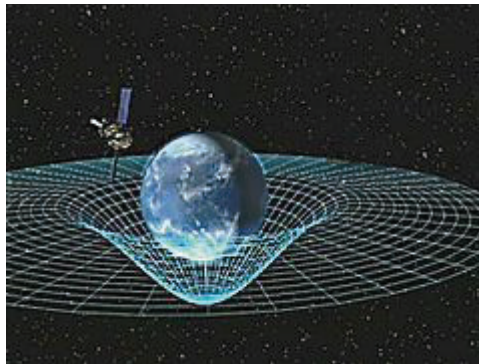

Figure 2.14. An illustration of spacetime curving around a massive object with respect to Einstein's tensor field equations (released by NASA).

Einstein bases the gravitational field on the spacetime fabric surrounding the massive objects in space that take place due to general relativity. For the three-dimensional space and time, field theory covers a type of tensor equations rather than the case we simply described earlier, in figure 2.11, as $x-t$ curvature, giving rise to acceleration that corresponds to a gravitational field. This tensor equation describing the spacetime fabric is shown in figure 2.14; four-dimensional spacetime curving around a spherical object is given as the following Einsteinian field equation:¹⁷

$$G_{\mu\nu} \equiv R_{\mu\nu} - \frac{1}{2}Rg_{\mu\nu} = \frac{8\pi G}{c^4}T_{\mu\nu} \tag{2.15}$$

where $G_{\mu\nu}$ is the Einstein tensor, $R_{\mu\nu}$ the Ricci tensor, and $T_{\mu\nu}$ the energy-momentum tensor, $g_{\mu\nu}$ the spacetime metric, and R the curvature scalar. G is the gravitational constant in the Newtonian equation of gravitation, insuring that Einstein’s field equations reduce to the classical gravitational law of Newton in the weak-gravity and low-speed limits. The equations with the cosmological constant Λ involve a third term and can be written as

$$G_{\mu\nu} \equiv R_{\mu\nu} - \frac{1}{2}Rg_{\mu\nu} + \Lambda g_{\mu\nu} = \frac{8\pi G}{c^4}T_{\mu\nu} \tag{2.16}$$

explaining the large-scale dynamic of the cosmos involving dark energy.

Orbital and spinal movements of the massive particles cause small ripples or disturbances in the spacetime fabric described by the field equations; these are called gravitational waves (described also in Chapter 1), which are propagated with the speed of light. This effect itself is proof that it is a fact of relativity observed due to light bending.

As a demonstration of the gravitational field invoked by the spacetime curvature, one clever illustration is of stretched fabric curved by heavy objects dropped on it, showing that the small objects move toward the large objects or orbit around them, as seen in the following video shot, which can even be tried at home.

¹⁷ Following the conceptual concerns of this work, we will not give extracts; however, for further information, see H. Stephani, D. Kramer, M. MacCallum, C. Hoenselaers, and E. Herlt, *Exact Solutions of Einstein’s Field Equations* (Cambridge University Press, 2003).



A snapshot taken from a video of Dan Burns explaining his space-time warping demonstration at a high school, 2012.

Understanding four-dimensional space

Probably I would not be wrong to say that the universe started with a point with no dimensions in the Big Bang. Then the three spatial dimensions were developed with the expansion. Time as the fourth dimension developed later, after light was decomposed without being absorbed by the plasma.¹⁸ This doesn't mean time didn't exist to start with. Time was there from the start, but it wasn't a dimension until photons became relativistic. Time gained its dimensional meaning with the propagation of light because the relativity of time appeared with light spread out to space via photon decoupling.

We cannot imagine the existence of the fourth dimension because we are all trapped in three dimensions. It is very difficult to distinguish the fourth dimension if you have been experiencing only the existence of the three from birth to death, since we do not have any experience of high gravity or reaching the speed of light in normal life. However, this doesn't mean that more dimensions don't exist. Einstein says, if one lived in one dimension (1D), one wouldn't realise the second; or if one lived in two dimensions (2D), one wouldn't realise the third. I shall extend this argument to the fact that if we are trapped in a point (zero dimensions), we would not

¹⁸ It is thought that the early universe was a very high-density and high-temperature state like plasma.

be aware of no dimensions. Therefore, since we live in three dimensions (3D) without observing the effects of the fourth one in everyday life, we refuse the existence of the fourth dimension, which is the time dimension. Perhaps there are more but the relativity theories presently predict four dimensions (4D).

If all the dimensions are invariant to you, then you are restricted in a dimensionless point where the origin of the universe probably started. As the universe started to expand, the other dimensions developed. If one dimension is variant and the others are invariant, then you are living in 1D. If the two are variant and the others are invariant, then you are in 2D. On the other hand, if three-dimensions are variant and only time is invariant for all the frames of reference, then you are in everyday life, as in the case of Galilean relativity.

If time is not absolute and invariant from various perspectives, then one has to introduce it as a fourth dimension. One cannot say a piece of paper is two-dimensional just because it is thin. Even if there is only a very small change in height, then one must accept that paper is three-dimensional. Now, following these arguments, one cannot say time is not a dimension just because one cannot feel the variance from the frame of reference that one is at.

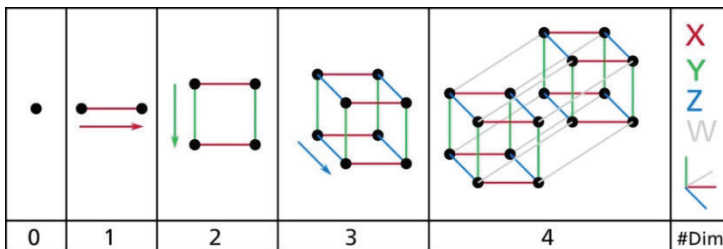

Figure 2.15. Projection of four dimensions on a two-dimensional plane.¹⁹

¹⁹This file is licensed under a Creative Commons (CC) license, a non-profit organisation devoted to expanding the range of creative works available for others to build upon legally and to share.

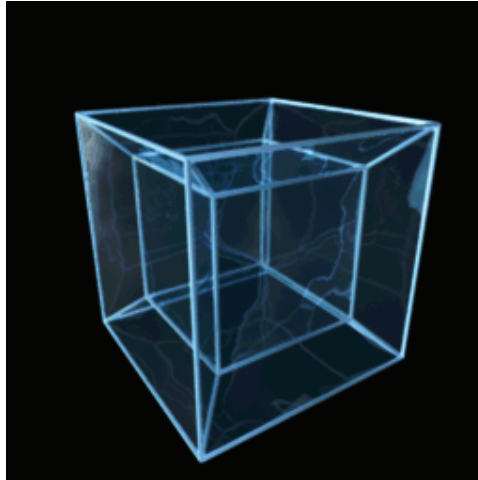
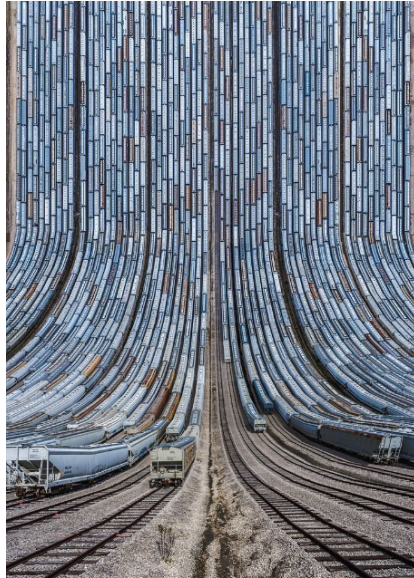

Figure 2.16.²⁰ Projection of 4D cube (tesseract) in 3D having four dimensions; length, width, height, and additional “trength.”

Now let us think that we live in two-dimensional x - y space and z is invariant for all the frames of references in the x - y system. You would see all the cubes as squares as in figure 2.15-(2). You can probably imagine the projection of a cube in 2D space that we usually draw on the blackboard in classrooms, as in figure 2.15-(3). As you can see, none of the angles in figure 2.15-(3) are right angles, although we know that a cube has right angles. Now, you cannot imagine or show what a 4D cube looks like because we are all restricted by 3D space and it is impossible to illustrate another dimension perpendicular to the three others. On the other hand, you can probably imagine what a 4D cube looks like in 2D space on a sheet of paper, and the answer would probably be like the one in figure 2.15-(4). Projection of this in 3D would probably look like the one in figure 2.16, which is called a *tesseract*, as it has four dimensions: length, width, height, and additional *trength*.

²⁰ This work has been released into the public domain by its author, Jason Hise.



An extraordinary visualisation taken by a photographer²¹ who looks at the world from different perspectives.

Even in daily life, you can extend the perception of dimensions, as in the above photograph by Turkish photographer Aydın Büyüктаş, who looks at the world differently from his objective, visualising ordinary photo angles to look multidimensional.

Now let us have a look at the additional dimension from a different perspective. Imagine that you are minuscule and live on a sheet of graph paper, and that by walking on the paper in any direction you can only reach the edges of the paper. You would think that this was all there is; you are stacked in 2D space, since the third direction is invariant to you. Now, think that a third dimension is created by wrapping up (curving) the paper into a sphere or a cylinder just as in the case of spacetime curvature in general relativity. As you continue in one direction, if the curving is broad enough, you might still think that you are in 2D space without realising the third dimension until you reached a point (which is marked) that you recognised from earlier on the sheet of paper. In this case, it is possible that you could return to where you started with the help of an additional dimension and that you realise that there exists one additional third dimension that is variant.

²¹ Courtesy of photo artist Aydın Büyüктаş.

The time dimension is just like this. You cannot realise that the time dimension exists if you think it is invariant as you move around in the classical Galilean space, that is, in normal space. However, if someone like Einstein or Lorentz shows you that time is variant from different perspectives, when you are moving with a speed close to c or under the effect of gravity, then you have to recognise that time is really another dimension of the universe.

On the other hand, one can speculate that if time is not the same for all frames of reference (relative), how can we determine the age of the universe? Thus, it must be the age of the universe relative to Earth that is meant. Yes, it is the age relative to Earth and it has been shown that the cosmic microwave background radiation (CMBR) explained in Chapter 1 is isotropic. This means that time is identical in all directions. Therefore, the time we measure is nearly absolute time²², since the velocity of Earth in the universe is not close to relativistic velocities. Therefore, we rely on the age that is determined with respect to Earth, as far as the observed universe is the one that is exposed to observatories on or around Earth.

²² The standard time unit of *second* comes from the second term after the minute in an hourly based algorithm, which corresponds to “sania or thania” in Arabic meaning also “two” or “second”. The term *split second* is given with the word “selase or thelathe” in Arabic meaning “three”, which corresponds to the third term after the second in the algorithm.

CHAPTER THREE

PRINCIPAL PRINCIPLE: UNCERTAINTY

“Not only is the Universe stranger than we think, it is stranger than we
can think”
—Werner Heisenberg



Photo of German physicist Werner Heisenberg printed on a stamp issued in his memory.

I find it rather eerie and frustrating that the whole universe is standing on two fundamental matters of indefiniteness: relativity and uncertainty that were both coded with the initial conditions of the universe. Einstein formulated the first, which is explained in the previous chapter. He started with special relativity and comprehensively ended up with general relativity,

introducing the spacetime fabric that holds the whole universe together with gravity. The latter was postulated by Heisenberg and resulted in extraordinary quantum fields that explain the interactions between the elementary particles, nucleons, and atoms holding the known matter together.

Although the inventors of the two basic principles had conflicts on the uncertainty, as we interpret from Einstein's famous expression "God doesn't play dice with the universe," their two principles are the most important indispensable rules that govern the universe, or at least the observable universe. While general relativity is explained in the previous chapter, this chapter's main issue is Heisenberg's *uncertainty principle* (HUP). Although I introduced HUP as the first principle of the universe in Chapter 1, since it originates in the very early conditions of the universe during the cosmic inflation, its understanding by humankind dates back only to 1925 after the birth of quantum mechanics in 1900 by Planck.

Fundamental quantum mechanical implications

By the end of the nineteenth century, the deterministic views of classical theory came up against statistics in thermodynamic phenomena, where the repetition of the same event and the multiplicity of different events come into play. Consequently, the multiple recurrence of one particular phenomenon in many microscopic and macroscopic events needs not end up with the same results.

The first comprehensive theory was that of Maxwell–Boltzmann statistics (1871), which evaluated the possible ensembles of an isolated thermodynamic system with the particular values of a continuous energy range. Until then, it was thought that classical physics had sufficient perspectives to understand all physical phenomena consisting of particles (matter) and vibrations (ordinary waves) obeying Newton's laws of motion, and radiation (electromagnetic waves) fitting into classical Maxwell equations of electromagnetism. The following points at which classical physics diverges revealed the fundamental quantum mechanical implications, which are explored below.

Blackbody or thermal radiation

To put it simply, matter, having a temperature of T , emits electromagnetic radiation depending on body temperature, which is in general called the blackbody or thermal radiation. Conventional tungsten light bulbs, electric heaters, and central heating radiators are examples of thermal radiators working at high temperatures. Thermal cameras also work on the bases of the thermal radiation disseminated from the environment. For example, you

can identify a person with a fever by sensing the thermal radiation emitted from his/her body with thermal cameras at an airport. We can even give examples of sensors used in automatic gates, alarm systems, and so on.

This electromagnetic thermal radiation became the “wallflower,” becoming an issue of conflict because late-nineteenth-century classical predictions of physics could not comprehensively explain the experimentally observed spectra of thermal or blackbody radiation, especially in the lower wavelength range of the spectrum.

Planck in 1900 introduced the term *quanta* by explaining the quantum behaviour of the thermal or blackbody radiation. According to classical beliefs, the thermal radiation should have been infinite when the temperature of metals continually increased following the classical theory of the Rayleigh–Jeans law given by equation (3.1), rendering the spectral distribution (see the far right plot of figure 3.1) of blackbody radiation, where λ is wavelength, k the Boltzmann constant, and T the temperature of the blackbody radiator.

$$\rho(\lambda, T) = \frac{8\pi}{\lambda^4} kT \quad (3.1)$$

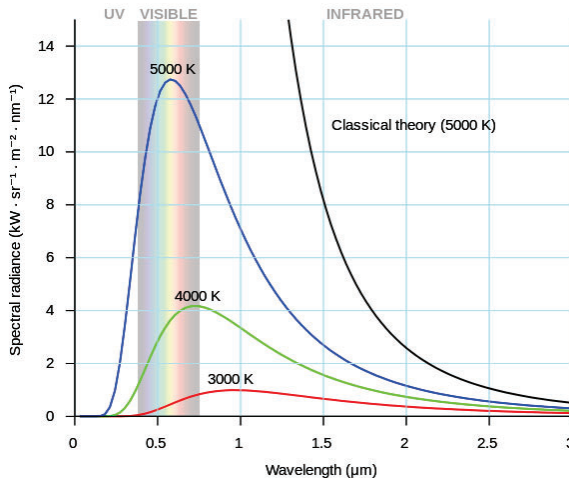

Figure 3.1. Spectral distribution of blackbody radiation as measured (the coloured curves) and theorised by the Rayleigh–Jeans model (the black curve). Planck’s distribution fits into experimental results, while the classical theory doesn’t. The cosmic blackbody radiation shown in figure 1.3 is similar to that of Planck’s in a range of micro-radio wavelengths, giving the CMBR at a low temperature of 2.7 K.¹

¹ Reproduced after a public domain work that can be copied.

As can be seen in figure 3.1, the classical distribution cannot explain the blackbody radiation except that it extrapolates to the experimental data in the long wavelength range.

Let us now have a look at the predictions that made Planck's revolutionary theory successful. Planck's quantum theory suggested that electromagnetic radiation could be dispersed by an energy quanta of $E_0 = h\nu$ called photons, where E_0 is the energy of a photon with ν frequency, and h the Planck constant. This is to say, the energy of the photons at a given frequency ν cannot take on any continuous value from zero to infinity but can take on only the integer values of nE_0 ($n = 0, 1, 2, \dots \infty$). In other words, the emission from the blackbody is quantised with the packages of $h\nu$. This idea simply combines the energy and frequency with particle and wave behaviour, respectively.

There are many other examples of blackbody radiators, such as a bunch of hot lava emitting red to yellow wavelength light or a piece of metal emitting invisible infrared to red and white light, depending on temperature, as shown in figures 3.2 and 3.3, respectively. The colour of the thermal or blackbody radiator depending on the temperature is called the *colour temperature*.

Following Newton's famous statement, "The best way to understanding is a few good examples," let's consider whether we are going to assume that the blackbody or thermal emission is like water spilling from a bucket or apples falling from a basket.



Figure 3.2.² The blackbody or thermal radiation of a flow of hot lava, exhibiting black-red-yellow colours, respectively depending on temperatures from colder to hotter domains.

² Image taken in Hawaii in 2003 released into the public domain by the US Geological Survey.

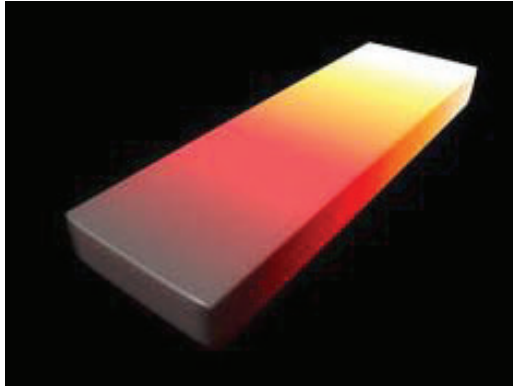

Figure 3.3. The thermal radiation of a piece of metal exhibiting a gradual increase in temperature from the near end to the far end, indicating also how the colour temperature changes.

The difference between Planck's thoughts and classical ones appears at exactly this point. The differentiation of ideas between the classical and quantum mechanical phenomena resembles the continuity of water in a bucket and the discreteness of apples in a basket, respectively. Therefore, replacing the continuous mathematical operations \int [letter of S (for summation) in Latin in a continuous shape] with discrete \sum [letter of S (for summation) in Greek in a discontinuous shape] in all the classical predictions would convert the equation (3.1) to a totally different expression of Planck's radiation law that matches exactly with the experimental data

$$\rho(\lambda, T) = \frac{8\pi h\nu}{\lambda^4} \frac{1}{\exp(h\nu/kT) - 1} \quad (3.2)$$

which was later on shown to obey the Bose–Einstein distribution (second fraction in equation [3.2]) of bosons, since a photon is a boson.³ This equation also reduces to the Rayleigh–Jeans model at extremely long wavelengths, that is, at low energies or at low frequencies. Likewise, when apples are small enough (small $h\nu$, low frequency, long wavelength), as small as water molecules, pouring apples would be the same as pouring water.

The universe is so coded that it graces things with packages of quanta rather than in a continuous and infinite manner. It doesn't mean that this situation is not valid at the macroscopic scale. It means that, at the macroscopic scale, discontinuities are so small in comparison to large-scale

³ Particles having integer spins.

variables that we mistakenly take them as continuities. Conversely, discontinuities happen to be so apparent at the microscopic scale that the quantum mechanical predictions ought to come into play.

Correspondence principle

The first principle analyses of the question, ‘how are we going to move from classical to quantum utilisations?’, became the *correspondence principle*. Although quantum physics involves some novel and very sophisticated theories and principles, this has not caused a complete break with the past. For instance, Newtonian mechanics still concretely stands in the macroscopic world, and Faraday’s induction law remains as the basis for producing electricity. Quantum mechanics is so comprehensive that its principles can be reduced to classical Newtonian mechanics under special conditions where the classical approach can satisfactorily be applied.

This is in general called the *Bohr correspondence principle*.⁴ For example, Fermi–Dirac statistics of modern physics applied to the microscopic phenomena of fermions is reduced to classical Maxwell–Boltzmann statistics, which can quite happily be applied to the systems in the classical regime, such as an ideal gas.⁵ On the other hand, we have also shown that the classical Rayleigh–Jeans model can satisfactorily be applied for the blackbody radiation at longer wavelengths instead of Planck’s quantum radiation model, as shown in the previous blackbody radiation section. This means that there are some rules of classical physics that can be satisfactory up to the edge of some scales or levels (the classical limits or so-called correspondence limits), at which there wouldn’t be any objection from quantum physics.

Wave-particle dilemma

Planck’s predictions, considering the wave dispersion in a discrete manner, eventually led to the well-known fact called the wave-particle dilemma: When Planck mathematically solved the blackbody problem (occasionally known as the thermal electromagnetic radiation problem) in 1900, I am not quite sure even he at the time knew that this invention was going to have a revolutionary effect in physics and was going to lead to a modern version—quantum physics—without which today’s discoveries in science and technology would not have emerged. In 1905, Einstein explained the photoelectric effect,⁶ assuming a photon could be imagined as a particle. It

⁴ See, for example, B. H. Bransden and C. J. Joachain, *Introduction to Quantum Mechanics* (Longman, 1989), 31.

⁵ C. Kittel, *Thermal Physics* (New York: John Wiley & Sons, 1969).

⁶ One of the early quantum effects illustrating that a photon is a kind of particle.

was demonstrated that photon energy could be converted to the kinetic energy of electrons escaping from a metal surface, in this extraordinary phenomenon.

Conversely, in 1923 Compton demonstrated an unusual electron behaviour and this strange effect was named the Compton effect after him.⁷ In his experiment, it was originally shown that the scattered X-ray from a crystal had two components. The first was quite expected, corresponding to the incident ray. The second was shifted to a longer wavelength called the Compton shift. Later it was shown by experiments on metals, where electrons are loosely bound, that the shifted spectrum at the longer wavelength belongs to the electrons and not the incident ray. This was to arrogate an electron having wavelength, called the Compton wavelength of an electron. The difference between Compton scattering and Einstein's photoelectric effect was that the incident photon energy in the first was higher than the latter. In 1923, de Broglie generalised the idea with his postulate, assigning all particles a wave parameter called the *de Broglie wavelength* given by

$$\lambda = \frac{h}{p} \quad (3.3)$$

resulting in an important term, *matter wave*, where h is the Planck constant and p the momentum [(*mass*) \times (*velocity*)] of the particle. This conflict between the idea of the photon as a particle of light and the matter wave of each quantum system is the famous *wave-particle dilemma* of quantum physics.

Although it was a dilemma, physicists didn't take it as unscientific, and Schrödinger formalised this (probably) unwanted situation in 1926 with the fundamental equation named after him, in which every quantum mechanical system needs to have a waveform:

$$i\hbar \frac{\partial}{\partial t} \Psi(\mathbf{r}, t) = \left[-\frac{\hbar^2}{2m} \nabla^2 + V(\mathbf{r}, t) \right] \Psi(\mathbf{r}, t) \quad (3.4)$$

where $\Psi(\mathbf{r}, t)$ is the position and time-dependent wave function of a quantum mechanical system, m the mass, ∇^2 the Laplace operator consisting of second derivatives of (x,y,z), and $V(\mathbf{r}, t)$ the interaction potential energy of the system at the position of \mathbf{r} and time t .

Essentially, the two operators are applied to the wave function to equate both sides. The first time-dependent operator on the left side of the equation $i\hbar(\partial/\partial t)$ is known as the energy operator and the latter in the brackets on the right side is the Hamiltonian operator consisting of the two kinetic and potential energy terms. This equation is simply a differential equation, the

⁷ One of the early quantum effects illustrating that an electron is a kind of wave.

solutions to which give the discrete quantised energy levels and the wave functions of a particular quantum mechanical system. This formulation establishes a new type of mechanics called *wave mechanics* that is completely different from Newtonian mechanics in all aspects.

In stationary states such as in atomic and molecular situations, the time independent form of the Schrödinger equation can be written as

$$\left[-\frac{\hbar^2}{2m}\nabla^2 + V(\mathbf{r}) \right] \psi(\mathbf{r}) = E\psi(\mathbf{r}) \quad (3.5)$$

Solutions to this equation give the energy *eigenvalues* of a particular system described with an appropriate *eigenfunction* ψ . For example, Bohr's atomic model in 1913 generalised the idea of quantised electronic energy levels, postulating that the orbital angular momentum is quantised as $L = mvr = n\hbar$ with the intervals of reduced Planck constant \hbar . This was eventually confirmed by establishing the Schrödinger equations for a particular atom.

In general terms, the equation can be written as

$$\mathcal{A}\psi(\mathbf{r}) = A\psi(\mathbf{r}) \quad (3.6)$$

where A represents any quantity in physics and \mathcal{A} represents the corresponding operator. Solutions would give discrete quantum values (eigenvalues) of A . Wave functions might be as complicated as the *hermit polynomials* in the case of a simple harmonic oscillator or the *block functions* in the case of periodic structures such as crystals or the *gamma functions* in spin-orbit interactions for a starter second-year physics student. However, all of them explain very useful energy levels in particular systems such as the energy bands and the defect levels in semiconductors, for instance.

Probability function

In the wave mechanics of a quantum mechanical system given by the Schrödinger equation in equation (3.4), the accompanying wave functions $\Psi(x, y, z, t)$ are calculated for individual quantum systems, and $|\Psi(x, y, z, t)|^2$ gives the probabilities of where the quantum mechanical species may be situated in space at an instant t . This was shown by Born in 1926, whereas Newtonian mechanics doesn't imply such probabilities. This probability function shows that there ought to be either a distribution of particles in (x, y, z) space or uncertainty of space for a certain particle. Nevertheless, readers should not misunderstand this to mean that Newtonian mechanics is more comprehensive than quantum mechanics just because the former is more deterministic. The latter is a result of experimental facts that are more explanatory and appropriate for us to understand the microscopic world and, consequently the macroscopic world as a whole. In general, provided the entire momentum p of a particle is uncertain, the de Broglie

wavelength of a particle is considered to be in the order of its uncertainty in space because the square of the probability function means that the particle is probably at the places where the wave function is spread out in space.

Exclusion principle

The *Pauli principle* or *Pauli exclusion principle* appears in many body systems in order to identify the quantum states of each particle. One of my ex-scholars, Professor Özbay, used to say that “two electrons cannot be at the same address, can they?” when he used to explain this principle.

This is a requirement when you look at the wave function of a system composed of N *fermions*,⁸ which is represented by the overall combination of the wave functions of each particle, appearing as the *Slater determinant*.⁹ It can be shown that if any of the quantum numbers of two particles are identical, the wave function of the system given by the Slater determinant vanishes, emphasising the impossibility of such a situation. This is to say that two particles cannot have identical quantum numbers, that is, it cannot be at the same quantum state, just as Pauli expressed when he explained the structure of atoms in 1925.

Quantum entanglement

Following from the exclusion principle above, quantum entanglement is similar to thinking of two “wheels of fortune” with red and green labels only. In the macroscopic analogy, if one stops on red, then the other has to stop on green, spontaneously and simultaneously, independent of one another. Of course, this is macroscopically impossible unless it happens within a probability or there is a sort of physical mechanism between the two.

However, the microscopic phenomena contains one of the most extraordinary implications of quantum mechanics, the *EPR paradox*, which came about through the paradoxical thoughts of Einstein, Podolsky, and Rosen when they were trying to contemplate the ideas of quantum physics. They raise the question of how it is possible to come to two separate particles of the same kind of *entanglement*¹⁰ while the fastest communication takes place at the speed of light. The entanglement is locally fine in *naturally entangled systems* such as an atom having one electron spin up and the other spin down in the sense of the Pauli principle. However, it is paradoxical for the particles at far distances on the same axis positioned respectively at x_1

⁸ A particle having a half integer spin.

⁹ For further reading, see B. H. Bransden and C. J. Joachain, *Introduction to Quantum Mechanics* (Longman, 1989), 453.

¹⁰ Einstein called it “spooky action at a distance.”

and x_2 , according to the special relativity postulating that nothing can exceed the speed of light. One solution was to accept that quantum mechanics is incomplete and needs to involve some “hidden variables” to overcome uncertainty, which is the main issue of this chapter.

The experiments to disprove such a phenomenon failed, confirming that quantum entanglement is a fact rather than a paradox. For example, it has later been shown in *quantum biology* that even robins’ eyes, under the effect of the Earth’s magnetic field, use this weird quantum link like a compass to find the right direction when they migrate from north to south or vice versa.

Although the *Copenhagen interpretation*,¹¹ as usual, supports the quantum theory by an explanation of quantum entanglement, I would prefer to take this issue as a “fundamental fact” and one of the unresolved “secret codes of the universe” without any interpretation so as not to lead to complications and confusions.

Quantum entanglement can also be interpreted as a kind of “quantum telepathy” or “quantum teleportation.” Therefore, a vast amount of research is being done on the issue in the sense of very fast communication and quantum computing in information technologies.

Origin and interpretation

As we have already discussed in the Creation section of Chapter 1, the natural and universal existence¹² of Heisenberg’s uncertainty principle (HUP) originated from scale invariant quantum fluctuations. These fluctuations were initiated during the inflationary epoch, recalling the fact that the entropy fluctuations of $\pm\delta S$ consequently resulted in the energy fluctuations of ΔE in Δt amount of time, and this happened in the order of a universal constant, \hbar . The constant is called the reduced Planck constant

$$\hbar = (h/2\pi) = 1.06 \times 10^{-34} \text{ js}$$

which is in the dimension of

$$[\text{energy}] \times [\text{time}] = [\text{length}] \times [\text{momentum}] = [\text{angular momentum}]$$

The position-momentum¹³ diagrams of a physical system describe the overall situation of the system. The dimensions of these physical quantities are called *action* and consequently Planck’s constant h is called the

¹¹ The school of Bohr and Heisenberg.

¹² K. Fujikawa, “Universally Valid Heisenberg Uncertainty Relation,” *Phys. Rev. A* 85, no. 6 (2012): 062117.

¹³ Etymologically *momentum* means “time” and *position-momentum* corresponds to spacetime. It means that the uncertainty is the uncertainty of each point in the spacetime fabric. In mystical theology, God is thought to be exempt from spacetime.

*fundamental quantum of action.*¹⁴ The value of the constant arises from the first stage of the universe named also in his honour, as the “Planck epoch.”

In the classical theory, that is, in Newtonian mechanics or from the macroscopic perspective, we can measure more or less precisely without any doubt the two basic quantities of where something is and what its momentum is, except for the experimental errors arising from the tools and observations that are independent of each other. It is our first and most important duty to notice that these kinds of systematic and observational errors have nothing to do with the uncertainties that appear in the HUP.

In fact, in classical physics, if you measure a position more precisely, you consequently measure the velocity and, therefore, momentum more precisely. However, according to the HUP in quantum physics, it is exactly the opposite. It means that if one measures the first more accurately, then one has to compromise the accurate definition of the latter. In quantum mechanics or from the microscopic perspective, this principle that we can measure things a hundred percent ceases to apply even in the most sophisticated and technically errorless instruments.

Let us suppose a particle such as an electron has a momentum p and a position x . The position and momentum conjugates, or correspondingly the energy and time, which are considered to be the basic quantities that constitute classical Lagrangian space, explain the whole story of the movement. Heisenberg in 1925 highlighted an important reality in quantum physics—the uncertainty principle. The principle states that the basic quantities (position and momentum) of a physical event, must have uncertainties Δx and Δp or corresponding uncertainties in energy and time: ΔE and Δt , respectively. If one can measure or calculate the former precisely, then one has to give up any certainty as to the latter. In between, there always exist possibilities of uncertainties in both, even in a perfect experiment. Sizes of uncertainties are not independent, and they are related by $\Delta p \Delta x \sim (h = \text{Planck's constant})$. So, for instance, if we can measure x exactly with nearly zero-uncertainty, then the uncertainty in p must be very high, in order to keep the product constant.

These uncertainties lead to many strange things: for example, in a quantum mechanical world, we cannot predict where a particle will be with 100% certainty. We can only speak in terms of probabilities. We can say that an electron will be at one location with a 95% probability, but there will be a 5% probability that it will be somewhere else. Let us state that this is the most unconventional aspect of quantum physics at the microscopic scale

¹⁴ For further reading, see B. H. Bransden and C. J. Joachain, *Introduction to Quantum Mechanics* (Longman 1989), 9.

that differs from classical physics at the macroscopic scale. However, we should not forget that the microscopic world forms the elementary components of the macroscopic environment.

No one has definitively demonstrated a correct interpretation on this uncertainty as to whether it is a fundamental way that the universe works or it is an artefact that appears whenever we make a measurement because we must interfere with the system that is under investigation. Whatever it is, it is a fact that it happens. We have to live with this reality. A unique interpretation of the uncertainty principle given by Penrose¹⁵ is also recommended for further reading.

The predictions of quantum mechanics are also valid in the macroscopic world. However, they approximate to Newton mechanics in the macroscopic limit so that their full application becomes dispensable. The reason why the uncertainties cannot be observed in the real macroscopic world may be explained by the synchronicity of events that was conceptually invoked as the “togetherness principle”¹⁶ by Jung as early as the 1920s. According to this principle, it is explained that the overlap of various synchronised events with a causal relationship in a combined macroscopic system results in zero-uncertainty. Consideration of quantum philosophy together with the synchronicity principle may result in new paradigms in quantum mechanics. A detailed discussion on how quantum mechanical implications construct macroscopic phenomena in the real world is given in the philosophical section.

On the other hand, we can probably more simply understand why the uncertainties are not apparent at the classical macroscopic scale. It is rather simple to think that the de Broglie wavelength of a particle would provide the order of the uncertainty in space considering the momentum changes from zero to p , according to equation (3.3). Let us now comparatively think of a stone (macroscopic) having a mass of 1 kg and an electron (microscopic) having a mass of $m_e = 9.1 \times 10^{-31}$ kg, and that eventually both of them would reach a velocity of 1 m/s from a stationary state. Taking a weird calculation of the orders of the de Broglie wavelengths of both, it works out to be respectively $\lambda_s \sim 10^{-34}$ m and $\lambda_e \sim 10^{-3}$ m (1 mm), as shown in figure 3.4. The first one is not unusual for a scale of stone while the latter shows a huge uncertainty in the electronic scale. It means that the position of the stone can be defined with an accuracy of one out of 10^{34} , while the

¹⁵ R. Penrose, “Uncertainty in Quantum Mechanics: Faith or Fantasy?” *Philosophical Transactions of the Royal Society A—Mathematical Physical and Engineering Sciences* 369, no. 1956 (2011): 4864–90.

¹⁶ R. Tarnas, *Cosmos and Psyche* (New York: Penguin, 2006).

electron is lost within 1 mm uncertainty in comparison to its femto-metre diameters. I do not know how useful it is to attempt to do such calculations; nevertheless, I think it helps us understand the apparent difference of why we cannot pick up uncertainties at the macroscopic scale, while they are a big issue to deal with at the microscopic scale.

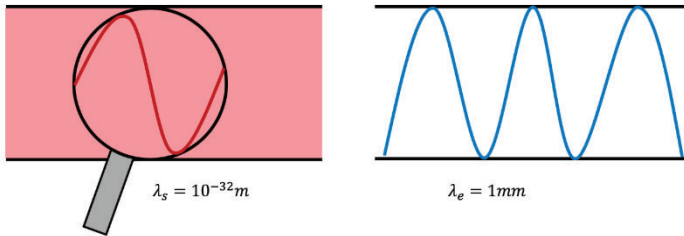

Figure 3.4. A brief illustration of the de Broglie waves for a stone and an electron, indicating the triviality of the uncertainty at the macroscopic scale and the importance of that at the microscopic scale.

Heisenberg's microscope

A thought experiment hypothesised by Heisenberg considers measuring the position of a particle using the scattered gamma rays under a microscope. The most basic principle of microscopy is that if one deals with a microscopic particle or a system, one needs to resolve it with a light that has a wavelength in the order of its dimensions. For example, in order to resolve the crystal structures, the X-rays need to be incident since their wavelengths are in the order of interatomic distances in crystals, which are both in the order of Angstroms.

Even in the visible region, we have the naked-eye resolution of the visible wavelengths ranging from 400–600 nm. For example, bank cashiers monitor banknotes under the illumination of a special light source called a black light bulb (BLB), which has the shortest visible wavelengths of the violet range, in order to have more resolution than the longer wavelength visible lights.

Returning to the microscope, if one wants to increase the resolution, one has to decrease the wavelength of the incident light to have greater resolution and, consequently, determine more precise positions at the microscopic scale. By this way, while one increases the position accuracy, one decreases that of the momentum for the following reason: The decrease in the wavelength results in an increase in the energy of the incident photon that would result in greater interference with the particle and a change in its velocity, giving rise to a more extended range of velocities. This would

consequently cause a broader distribution of momentums. This is exactly what is meant by the HUP expressing that if you increase the position accuracy you reduce the momentum accuracy and vice versa. A rough illustration of the scattered photons' momentum and the wavelength distributions are shown in figure 3.5 as functions of the scattering angle.

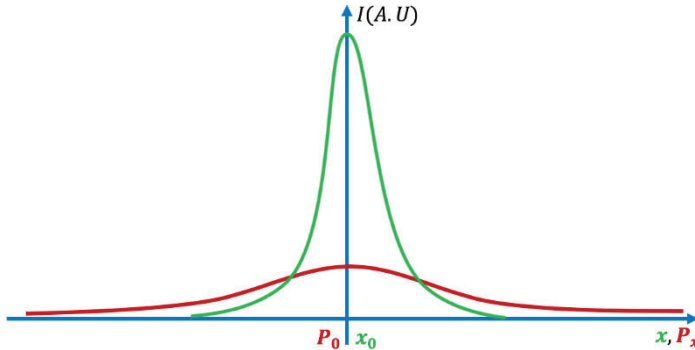

Figure 3.5. An illustration of position and momentum distributions obeying the HUP, exhibiting that more precise positioning gives rise to the broader momentum distribution and vice versa.

Quantum confinement

As a consequence of the HUP, the term *quantum confinement* is an important issue for some “state-of-the-art” applications in quantum mechanical structures and devices. The standard of determining whether a quantum mechanical system or a particle is “confined” is to examine whether the position uncertainty is comparable to the de Broglie wavelength. An appropriate analogy would be that prisoners would not feel themselves in custody in a room the size of a football pitch. However, they would feel “confined” in a room measuring just a couple of square yards.

A particular quantum mechanical system or particle can be restricted in its mobility in space due to certain particle–particle interactions or physical barriers around it. If these restrictions can be reduced to the orders of the de Broglie wavelength or its uncertainty in space, then the system would have rather different physical properties and quantum states than it usually has when it is free to move in larger volumes. This situation is called the *quantum confinement*. If the restrictions are extended to 3D, then it is called the *quantum dot*, to 2D, the *quantum wire*, and to 1D, the *quantum well*. In other words, speaking for one particle system with no rotation and vibration, the restrictions of the degrees of freedom to zero is the quantum dot, 1 the

quantum wire, and 2 the quantum well. Where the degrees of freedom are three, it refers to free particles in 3D space.

Considering a free particle with a mass of m , moving in zero potential, the accompanying wave function can be written as

$$\psi(\mathbf{r}) = Ae^{i\mathbf{k}\cdot\mathbf{r}} + Be^{-i\mathbf{k}\cdot\mathbf{r}} \quad (3.7)$$

where \mathbf{k} is the wave vector. We can determine that the solutions of the Schrödinger equation (equation (3.5)) result in the following continuous energy states:

$$E = \frac{\hbar^2 k^2}{2m} \quad (3.8)$$

On the other hand, if the same particle is confined in a cube with L dimensions, then it is possible to illustrate that the Schrödinger equation can only be satisfied with the discrete energy levels of

$$E_n = \frac{2\pi^2 \hbar^2}{mL^2} n^2 \quad (3.9)$$

where n is the quantum number having positive and negative integers including zero. Further restrictions due to certain external effects, such as pressure, a magnetic field, or an electric field, rather than only surrounding it with walls, may also result in some finer splitting in the energy states called the “degeneration.” Illustrations of the three situations are shown in figure 3.6.

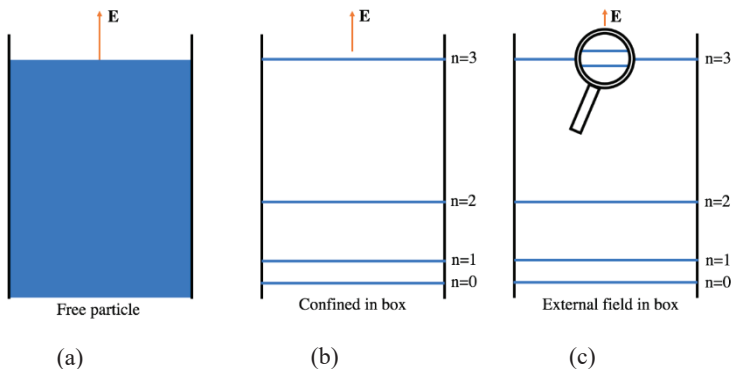

Figure 3.6. An illustration of (a) the continuous energy band for a free particle, (b) the discrete energy levels for a confined particle and (c) the discrete and degenerate energy levels for a confined particle under the effect of an external field.

To this extent, it is important that the uncertainty principle has these kinds of structures with discrete energy levels in terms of utilisations in various quantum devices as well as in nanoscience and technology. This property

finds many applications, such as quantum lasers, sensors, solar cells, and so on, as well as in magnetic resonance spectroscopy.

Tunnelling

If the barriers surrounding the particle were thin enough, as thin as the de Broglie wavelength, which is in the order of the uncertainties in space, then we would not define the particle whether it is behind or in front of the barrier, in the borders. There would always be a probability of the particle existing behind the barrier according to the probability wave function accompanying the incident particle. This situation causes an especially unusual effect that would not at all be the case in classical physics, called *quantum tunnelling*.

Think of how probable it is that if you are standing on one side of the wall of a room that you might find yourself suddenly on the other side of the wall, in the next room. Is that a possibility you can envisage in daily life? Yet it is a possibility in quantum phenomena, as shown in figure 3.7, if the wavelength of the wave accompanying the particle is comparable with the thickness of the wall or “well,” as we name it in quantum physics. We can understand this phenomenon if we reanalyse the situation in figure 3.4 as follows: in normal daily macroscopic life, wavelengths are so small, to the order of 10^{-32} m, that it is impossible to cross the barriers in m, cm, or even mm and microns.

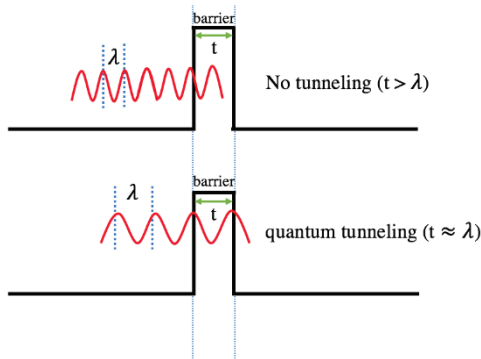

Figure 3.7. A schematic illustration of quantum tunnelling for a particle with λ wavelength being incident to a barrier with a thickness t .

However, this important phenomenon in the microscopic or, rather, in the electronic scales has found many applications such as the *Zener diode*, which renders a short circuit at the edge of a certain breakdown voltage acting as a constant voltage current source due to *Zener tunnelling*, as shown

in figure 3.8. The breakdown voltage can be adjusted from one to three digits by controlling the doping concentration in the semiconducting components of the diode.

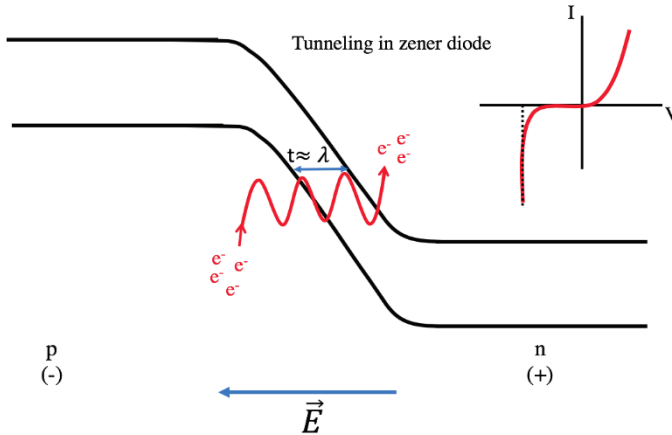

Figure 3.8. A schematic illustration of electrons tunnelling through the barrier built in a reverse biased p-n diode in which the particular application is named after Zener.

On the other hand, apart from the electronic applications mentioned above, quantum tunnelling has a vital effect on enzymes inside living cells in biology, accelerating the chemical processes so that it would otherwise take so much time that life wouldn't have been possible without these quantum processes.¹⁷

Uncertainty principle in quantum formalism

Another important result of the HUP is the commutation principle of quantum mechanical formalism. In normal classical mechanics, the commutation of the two basic quantities of Lagrangian space is possible as

$$qp - pq = [q, p] = 0 \quad (3.10)$$

This is basically true of classical mechanics because there would be no difference between defining q before p and vice versa. However, according to the HUP, the difference would be in the order of \hbar from the quantum mechanical point of view, because if you measure q first, then you have a complete uncertainty in p as $\Delta p \sim p$ or vice versa as $\Delta x \sim x$. In this case, the

¹⁷ N. Carlo, "Nature's Subway: Quantum Tunneling in Enzymes" (2010), available at <http://www.isgtw.org/feature/natur>.

commutation is not possible and it gives a value that differs from zero, having a value of \hbar :

$$[q, p] = i\hbar \quad (3.11)$$

where $i = \sqrt{-1}$ is the basic complex number and not to be confused, arising from the operator forms¹⁸ of q and p . This means that the position and momentum conjugates cannot be represented with the same wave function and cannot be measured simultaneously.

From the angular momentum point of view, it means

$$[L_x, L_y] = i\hbar L_z \quad (3.12)$$

Which exhibits that the components of angular momentum cannot be measured simultaneously. As a result of the commutation rules between the two conjugate variables, the HUP is “finely tuned” as

$$\Delta x \Delta p \geq \frac{\hbar}{2} \quad (3.13)$$

because from pq to qp , we would have twice as many of the uncertainties which appeared compared with \hbar . Therefore, in one turn, the product would be half¹⁹ of it.

For example, as a consequence of the fact that equation (3.13) is at least $(\hbar/2)$, the *zero-point energy* of a *harmonic oscillator*, oscillating with a frequency of ω , would correspond to $(\hbar/2)\omega$, while the stationary classical one would be zero. This is clearly a quantum effect resulting from the HUP since a classical pendulum at a stationary state would have no position uncertainty and, therefore, zero-energy. However, the same in quantum phenomena would have vibrations of ω around the zero-point due to the Δx uncertainty, resulting in the mentioned zero-point energy that is different from zero.

Social analogy

Heisenberg’s Uncertainty Principle in a way resembles the freedom and security imbalance in social life and judicial cases. If you increase freedom, then you might weaken security or vice versa. In between, even if you try to balance the social consensus by placing the laws, rules, or sometimes principles, you can set up neither 100% freedom nor 100% security. Determining the position and momentum conjugates in quantum physics

¹⁸ Every quantum mechanical quantity accompanies a complex operator in the same dimension such that the energy is $i\hbar \frac{\partial}{\partial t}$.

¹⁹ The HUP is originally given in the order of \hbar but it is readjusted as $\frac{\hbar}{2}$ after quantum formalism.

has almost exact similarities. Even a perfect experiment cannot determine them with 100% certainty.

Similar things come up with the confined and free particle situations. Confinement refers to less freedom. In this case, a particle can have certain energy states permitted to it by the Schrödinger equation, rather than all energy states from zero to infinity, as in the case of the free particle shown in figure 3.6(a–b), respectively. Likewise, in social life, confinement restricts the places where one can go. One can only go to places that one is allowed to by law. One cannot enter forbidden areas, while in 100% freedom there would be no restrictions at all; however, one still obeys the laws. A free particle is the same. It can have all the continuous energy levels but it will still obey the Schrödinger equation.

Another good example²⁰ is that the ball in a baseball game is almost like a free particle and position uncertainties are almost infinite. In this case, velocities should be more definite according to the HUP. In fact, when the players hit the ball, it goes in one direction for a long time having definite velocities and continuous energies. On the other hand, in squash for instance, the space is more restricted, that is, the ball is much more localised (less uncertainty in position) and bounces around, changing direction all the time, which generates greater uncertainty in velocity (consequently in momentum), resulting in the discrete states.

Semiconductors

As is well known, these important materials are the cornerstones of electronics. As seen in figure 3.10, they are the systems that host both free and localised particles at the same time, to the extent that the free electrons and holes are respectively in the conduction and valance bands, and the ones trapped at the defects between the bands. In fact, electronics is a game played with these particles, going on and around from localised to free situations releasing the free electrons or holes (carriers) in the conduction and valance bands, respectively, or vice versa, trapping the carriers at the defect centres from the bands.

²⁰ This is just an analogical example. Of course, the ball is an object of classical physics and has no uncertainties at all.

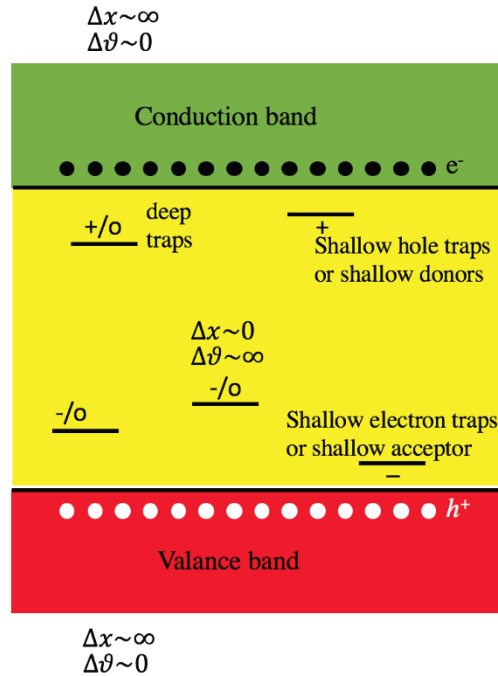

Figure 3.10. General illustration of the energy band diagram of a semiconductor. The colour coding is similar to that used for road traffic, the red is forbidden for free electrons, the green is fully allowed, and the yellow is the transition states.

Analysing figure 3.10 in terms of HUP, HUP also governs the semiconductor systems as follows: Having free carriers with more uncertainty in position within the bands (red and green regions) produces the continuous energy levels. On the other hand, the localised carriers at the traps (yellow region) have less uncertainty in position between the bands, producing the discrete energy levels. The electrons in the conduction band or the holes in the valence band are considered to be free having infinite uncertainty in position and zero uncertainty in velocity resulting in the energy bands. However, the electrons or holes at the traps between the bands are considered to be “localised,” having zero uncertainty in position and infinite uncertainty in velocity, resulting in the discrete energy levels.

The “detailed balance” between being free and trapped circumstances renders optimal working conditions for these “smart” quantum or more generally semiconductor devices such as diodes, transistors, sensors, LEDs,

and many others that constitute the tremendous technology that we enjoy nowadays.

Hidden variables

In fact, the HUP is the quantitative declaration of indeterminism, opposed to the deterministic views of classical mechanics. The ones who were against the idea of the probabilistic views of quantum mechanics invoked the idea of hidden variables, backing up the hypothesis of “incompleteness of quantum mechanics.” Especially Einstein et al. disagreed with the probabilistic view with the famous expression “I am convinced God does not play dice.” According to them there must be some parameters that quantum mechanics didn’t take into account, and as a matter of fact these new parameters should be defined, in order to explain and determine the things that quantum mechanics left undetermined within probabilities. One of the most important arguments was rendered from a paradoxical status of *quantum entanglement* called the Einstein–Podolsky–Rosen (EPR) paradox launched in 1916. However, it was later on proven that it is a reality rather than a paradox.

More generally “Bell’s ground-breaking theorem”²¹ later on suggested that no versions of hidden variables, either locally or non-locally, are impossible. As we recollect from Bell’s reverse arguments, if his theorem was in a way positive, it would have resulted in absolute determinism called “superdeterminism,” which I prefer to blame on God, for now. Although we should always take precautions on these kinds of issues even after a century, at least, for the sake of the unorthodox *de Broglie–Bohm theory*²² trying to establish alternative mechanisms to Schrödinger’s, the HUP stands as a reality that we have to cope with or perhaps, be comfortable with.

Philosophical implications²³

Heisenberg says, “What we observe is not nature itself, but nature exposed to our method of questioning.” From this methodological point of view, let

²¹ It was built by John Stewart Bell in 1964.

²² It was first set up by de Broglie in 1920 and later on abandoned with respect to Bohr’s Copenhagen Interpretation and his scholasticism. It was much later brought on the agenda by Bohm in 1952 and is still being studied by combining it with quantum fields and relativity, generally known as Bohmean mechanics.

²³ For further reading see, S. Tüzemen, “Advances in Modern Physics: Transition from Positivism to Post-positivism in Education and Research,” *Advances in Research* 6, no. 1 (2016).

us have a look at the main constituents of the philosophy of science and paradigms that are “ontology,” “epistemology,” and “methodology.” This is to understand why the philosophical approaches have to change while science is advancing or evolving, especially in terms of the quantum mechanical implications.

Ontology is the philosophy of entity in terms of the fact that science has to describe what the form or nature of reality is, or what is there that sciences can dig out. Epistemology is simply the philosophy of knowledge or of how we come to know the entities described by the present ontology. Methodology is a set of tools involving methods and techniques that enable sciences to get information in a more practical manner. In general, a particular piece of scientific research has to involve these three important issues, which are continuously affected by scientific innovations.

The methodological approach to a particular topic is very much dependent upon the views regarding ontological and epistemological questions. For example, according to Coll and Taylor,²⁴ “those subscribing to realist ontology and objectivist epistemology rely on inquiry that is experimental and manipulative, in which questions and hypotheses are stated and are evaluated by empirical testing. In this approach, careful control of experimental conditions is necessary to prevent outcomes being subject to extraneous influences.” This is more likely to be a positivistic approach, proposing that what science deals with is that which can be directly observed and measured. This is in a sense a true approach if everything was directly observable and measurable as in the classical physicists’ worldview.

Now, let me return to quantum mechanics and attempt to discuss what the new aspects that differ from the classical ones are.²⁵ As far as the ontological aspects are concerned, in quantum physics we cannot establish the form of species, that is, whether they are best treated as waves or as particles prior to an experiment. Only upon the experiment does the issue become meaningful. I propose that this reality in quantum physics invokes *relativist ontology* while classical physics is based on *realist ontology*. Einstein’s relativity theory also supports this assumption for modern science. This exemplifies the required transition from a positivistic to post-positivistic worldview. According to the positivistic view, the experimental parameters are fully defined a priori. However, as in Heisenberg’s

²⁴ R. I. Coll and N. T. G. Taylor, “Using Constructivism to Inform Tertiary Chemistry Pedagogy: Chemistry Education,” *Research and Practice in Europe* 2, no. 3 (2001): 215–26.

²⁵ For further reading, see, D. Murdoch, *Neils Bohr’s Philosophy of Physics* (Cambridge: Cambridge University Press, 1989).

uncertainty principle, quantum mechanics has produced evidence contradicting the realist ontology of positivism.

Let us now extend the philosophical discussion with a few arguments on the fundamental aspects of quantum mechanics between Einstein and other well-known founders of quantum philosophy such as Heisenberg, Bohr, and Dirac. Essentially, Heisenberg noted that there is an unusual relation between the precision of the two basic quantities of physics: position and momentum. If we measure the position precisely to certain accuracy, we cannot measure the momentum to certain accuracy and vice versa. This has been the main issue of this chapter. The basic differentiation between the two philosophical views that Einstein and others believed is whether this uncertainty is a natural way that the universe works or whether instead it is an artefact that appears when measuring these quantities.²⁶ Einstein, who said “God does not play dice with the universe” never believed that the uncertainty is natural.

However, Heisenberg postulated the uncertainty principle to be a fundamental principle of the universe and the lowest product of the uncertainties in the position and momentum conjugates is in the order of the Planck constant, which is a universal constant from the very early creation stage of the universe—the Big Bang. The conflict between Einstein and Heisenberg was finalised by the Copenhagen interpretation of Bohr’s Institute, postulating that we have to recognise this uncertainty without looking at it as natural or as artificial. Besides this, the fundamental notions developed by Schrödinger and Dirac, and the further predictions of quantum field theories, working very well in theoretical and experimental physics, are entirely based on this famous uncertainty principle.

I personally believe that this is an uncertainty given to human beings by God. I, in a way, agree with Einstein that “nothing is uncertain for God”; but I also agree with Heisenberg that “everything is uncertain for us.” In mystical theology, God is exempt from space and time, which can probably be interpreted as follows: these anti-deterministic issues on spacetime, as the relativity theories and the uncertainty principle dictate, are meaningless in His position. If, in a way, these were the parameters that were apparent to us with 100% certainties (as in superdeterminism), we would probably have had God’s abilities. The fact that we should face these uncertainties, suggests we have certain abilities restricted by Him, or you may prefer to say, by “nature.”

Accepting our disabilities and returning to the previous discussions, as far as the epistemological and methodological aspects of the philosophy of

²⁶ H. Kragh, *Quantum Generations* (Princeton University Press, 1999).

science are concerned, we cannot perform ideal experiments or establish ideal theories that uncover the truth contrary to the objectivist classical view of physics. However, we can perform experiments and establish theories that may approach the truth. Since approaching is an infinite process, we cannot know how close we have reached the truth at any one time.

This is a true assumption only from a post-positivistic quantum perspective: positivists believe that the values measured or observed by an appropriate method are a totally definite and correct way to reach the truth. In contrast to quantum physics, classical physicists could judge and come to conclusions with their measured or observed values in a positivistic way, because all the parameters of physical phenomena are correctly measurable and observable. However, this is not true from the perspective of quantum physics. What positivists or classical physicists did not criticise or ask themselves is, What is measurable and observable and to what extent? As a matter of fact, the answer to this question should be nothing but 100%. The discussions on the philosophy of quantum physics and post-positivism must be built on this particular point in the epistemology and methodology of modern sciences.

The first principle alternative to objectivism could be seen as subjectivism, which states that there is no external reality, but that the observer produces the findings of an inquiry. However, this is controversial within the post-positivistic worldviews, which prefer critical realism instead of subjectivism in the epistemological and methodological issues. A critical realist believes that there is a reality independent of our thinking about which science can study. While positivism strongly insists on realism, post-positivism is rather wary, supporting the philosophy of critical realism.

Post-positivists think that all observations could have the possibility of misinterpretation, misunderstanding, and error, and that all theory can be improved. Therefore, the objectivity in post-positivism is the right approach from a broader perspective including a more comprehensive spectrum of most scientific views, although positivism believes that the objectivity of an individual scientist extracts true information about reality, no matter what their paradigms are. Post-positivism indicates the fact that no individual can see the world perfectly as it really is. The philosophy of quantum physics is based on many parameters with uncertainties and probabilities, which also supports an objectivity of this kind in epistemological and methodological approaches.

One might speculate that the predictions of quantum physics are only valid for ontological issues in the microscopic world of atoms, molecules, and elementary particles, and that the outcomes of these predictions cannot be applied to the macroscopic scale. However, this is not correct. It has been

shown from many stunning examples²⁷ that microscopic entities affect macroscopic ontologies since the microscopic quantum world constitutes macroscopic nature.

The leading physicists of the early twentieth century, whether they were post-positivists or not, brought about great changes in our views about the universe, and their ideas and views undoubtedly made us reconsider the philosophy of science and methods of education. Today, the reflections on these views of science, technology, and education continuously advance our knowledge. Both in modern physics and post-positivism, extending the enquiry may lead to questions, and answers that could result in new types of physics and new philosophies of science. The future may be formed with these new ideas as it has been presently done by the implications of quantum mechanics and modern physics in general.

²⁷ See footnote 23, p. 5.

CHAPTER FOUR

FUNDAMENTAL FORCES

“God made and governs the world invisibly.”
—Newton

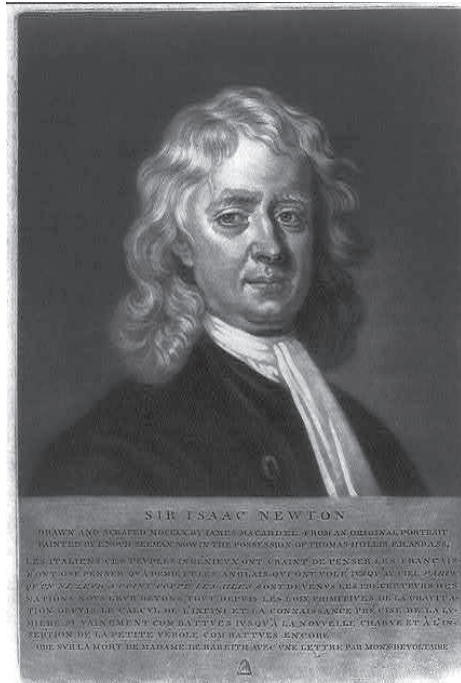

Sir Isaac Newton’s portrait painted by Polish painter Enoch Seeman and engraved by James McArdell, mezzotint, Library of Congress, Washington, D.C.¹

Let us start with the invisible things that Newton probably mentions, as stated above. I do not know whether he meant these things (force carrying particles) in exactly the same way we conceive it today; however, at the

¹ Image from the US Library of Congress Prints and Photographs Division.

time when he discovered gravity, he knew that there ought to be a mysterious something that governs and manages to produce force, holding the whole universe together, while there is no touch between the interacting species. He ended up saying “What we know is a drop, what we don’t know is an ocean” when he was probably fed up with very deep thoughts. Although what we still know is a drop across huge unknowns today, we know that there are at least the four sources of interactions and these are mediated by some invisible but observable particles that arose due to the initial prickles of the cosmos, especially due to quantum fluctuations that provoked Heisenberg’s uncertainty principle.

Newton’s invisibles are still invisible and yet unobservable, if he meant the mediating particles in gravitation, because the only mediating particles are that of gravity called *gravitons* (G), which are still theoretically standing off those of the four known interactions. In this chapter, we will try to discuss what the known interactions constitute and what kinds of physical phenomena cause them. Possible unifications between them will only be mentioned, without trying to understand the quantum tricks that cloth them one to the other in some special conditions and render certain physical parameters invariant.

History and ontological implications

Four fundamental forces are presently known that explain the entire interactions; however, certain physicists believe in the hypothetical existence of a fifth, named *quintessence*, which was mentioned in Chapter 1, in order to explain the accelerating expansion of the universe and, therefore, dark energy. However, the experimentally proven four—gravity, and electromagnetic, weak and strong nuclear forces—are explained and are experimentally combined in the *grand unified theory* (GUT) or in the *theory of everything* (TOE), which aims to tidy up some important twentieth-century theories such as the theory of general relativity, quantum field theory (QFT), and the standard models of cosmology and particle physics.

Gravity or gravitation

From Newton to Einstein, no matter where the descriptions, concepts, or, finally, paradigms differ, gravity is the first fundamental force that we experience in everyday life, like the air we breathe or the water we drink. It would be highly difficult to conduct our lives without it.

For example, one of the most important problems on a journey to Mars is keeping astronauts in good health in zero-gravity, since brain problems such as *hydrocephalous* and other forms of brain damage may be caused,

respectively due to the water shift to the brain and brain flotation, as may *osteoclasia*, due to the long period with no activity in a medium without gravitation, and the long-term exposure to cosmic radiation.

Although gravitation is the first that we experience, from birth to death, it was the last one that formed in the universe and causally was the least known in terms of the standard theory of the universe since there is no evidence at all for the mediating particles, nominally called gravitons. However, the spacetime curvature around the massive objects explained in Einstein's general relativity is currently the best explanation. Gravitation is rather monolithic, unlike electromagnetic interaction, which appears in both directions as repelling and attraction while gravity is only attractive.

Every fundamental interaction results in the quantum states just as the electromagnetic interaction results in the atomic energy levels and so on. Gravitation should also result in quantum states that are the issue of a novel subject called *quantum gravity*. Here I would like to mention some novel experiments and theories on quantum gravity,² predicting that a gravitational atom-like system should emit X-rays. However, there might be a fundamental mistake in this prediction because the gravitational field quantises the hypothetical gravitons rather than the photons. Therefore, the quantised outcome should be the gravitons, not X-rays, just like the photons that are emitted from the normal atomic quantisation due to electromagnetism.

Besides quantum gravity, Einstein's general relativity is still the only valid explanation for gravity, as explained in Chapter 2. In fact, the paradigms of Newton and Einstein on gravity differ in ontological meaning because Einstein did not consider it as a force in his general relativity. Gravity in the concept of general relativity is a consequence that we sense because spacetime curves around an object with a mass that may be a stone, planet, star, galaxy, black hole, or something else that has a mass. As we come closer to a massive object, the spacetime bending would result in a non-zero second derivative³ of space which would be counted as an acceleration in the dimensions of $[\text{Length}, L]/[\text{Time}, T]^2$, as has been previously shown in figure 2.11. Einstein imposes it as a feeling rather than reality, although, as I always repeat, he also said that "reality is merely an illusion, albeit a very persistent one."

In this sense, what we see as reality consists of perceptions. For instance, let's think that we witness a very valuable, antique vase that falls down from

² See, for example, P. Nicolini, "Noncommutative Black Holes, the Final Appeal to Quantum Gravity: A Review," *International Journal of Modern Physics A* 24, no. 7 (2009): 1229–308.

³ In this case, the first derivative representing the velocity is also non-zero. The velocity dependence is implicated within special relativity.

a table and is broken into pieces. It is an unfortunate fact in the vital concept while it is a bad feeling that is shown to us in the “spacetime game” of the universe, in the theatrical concept. I don’t know which one you would prefer to accept; the situation is, however, a mere reality that is persistently irreversible. Therefore, as scientists, we ought to accept these kinds of visualisations as reality as it appears in relativity or in uncertainty. We cannot repudiate them as scientific just because they are relative or uncertain.

Newton’s ontological view of gravitation is definitely in favour of force causing the gravitational acceleration, as in the story of Newton under an apple tree. Another important, but wrong impression in Newton’s classical paradigms is the assumption of gravity propagating with infinite speeds, while it is actually propagated in the speed of light, as it appears in modern physics. In fact, one of the most important differences between the classical and the modern concepts of physics is that zero and infinity do not exist in modern ontology. For example, we refuse “special relativity” in our normal lives because we think we observe everything at infinite speeds while it is in fact restricted to the speed of light in reality. On the other hand, the position of a point P can be zero in the classical concept while there exist uncertainties as Δx , Δy , and Δz around it, resulting in a non-zero minimum energy of a pendulum, for instance.

Another important matter in Newton’s gravitation law is the fact that it is a result rather than being causal. Causality is much more reflected in general relativity and in the Standard Model. On the other hand, it is important that Newton’s gravitation law is a reduced version of general relativity in special conditions and explains the inverse square feature of the universal laws.

Electromagnetic interaction

Every day, we experience what is publicly the second-best-known effect of electromagnetic interaction. Knowledge of electromagnetism dates back to very early times, as early as 2000–700 BC in historical Chinese sources and in Ancient Greece. In the latter especially, electricity and magnetism are largely associated with two kinds of material: amber (named *electron* in Attic Greek) and magnesia stone, probably a natural magnetite ore like Fe_3O_4 (dug out near the city of Magnesia or Manisa in Anatolia), respectively.

When human beings first see a piece of electrostatically charged amber collecting dust or a piece of magnet pulling metal lumps they are normally hugely surprised. Other, normally harmful experiences human beings have

with electricity are known from history, starting with atmospheric electricity, especially lightning.

However, the real scientific implications of electromagnetism were not discovered for millennia, until the important laws and principles of electromagnetism were developed by William Gilbert in 1600; Charles Cloumb in 1785; Alessandro Volta in 1800; Hans Oersted in 1819, and Jean Baptiste Biot and Felix Savart just after Oersted; Andre-Marie Ampere in 1821; Georg Simon Ohm in 1825; Michael Faraday and Joseph Henry in 1831; Heinrich Lenz and Moritz von Jacobi in 1834; Carl Friedrich Gauss in 1837 and earlier; and Sir William Thomson in 1853. Of course, finally the unification of electromagnetic theory with the equations of Carl Maxwell was possible in 1873. Heinrich Hertz experimentally proved Maxwell's predictions with the experiments on electromagnetic waves in 1888.

Although the ontological aspects of electromagnetism changed a lot—from an electrostatic or magnetic stone to electromagnetic waves—the discoveries of humanity on the electromagnetic effects nearly consist of everything we touch in today's technology and civilization. This technology certainly started with the early inventions of Nikola Tesla, Tomas Edison, and Alexander Graham Bell in the 1880s, respectively on electromagnetic induction, AC and DC current distributions, and the telephone.

The modern implications of electromagnetism start with the experimental discovery of electrons by J. J. Thomson in 1899 and the theoretical or rather semi-empirical discovery of quantum mechanics by Max Planck in 1900. Later approaches introduced by Dirac on electromagnetic interaction with matter in the 1920s and Fermi's weak interaction theory in the 1930s up to the mid-twentieth century developed the great theoretical considerations, such as quantum field theory (QFT) and quantum electrodynamics (QED). Further advancement occurred through the predictions of Higgs, Abdus Salam, Weinburg, and many others, merging the electromagnetic and weak nuclear forces into a single electroweak force with the involvement of the W - Z bosons⁴ that were experimentally confirmed in 1983.

Electroweak force

Electroweak force is a unification of the electromagnetic and weak nuclear interactions that we should mention together as follows: With respect to the ontological aspects, we can summarise that the electroweak interaction has

⁴ The mediating gauge bosons (the carriers of the fundamental forces) of all four interactions will be described later in this chapter.

four known interaction (gauge) bosons that are split into two kinds of interactions—electromagnetic and weak nuclear. They have massless photons in the first and the massive W^+ , W^- , and Z^0 bosons in the latter, in different physical conditions. This splitting is called *symmetry breaking* in gauge theory, which means that there exist two different mechanisms that satisfy the total quantum mechanical action in the electroweak circumstances. That is to say, it is rather a schizophrenic character warped into two totally different behaviours. The change of character swapping from one another occurs at a certain temperature called the critical temperature.

The inventors of the theory in 1968, Sheldon, Glashow, Abdus Salam, and Steven Weinberg,⁵ received the 1979 Nobel Prize. The interaction bosons being massless (photons) in electromagnetism and having mass (W^+ , W^- , and Z^0) in the weak nuclear interaction are explained with the *Higgs mechanism* developed in the 1960s by Higgs⁶ and independently by others, Anderson, Brout, Englert, Guralnik, Hagen, Kibble, and 't Hooft, so that even Higgs called his own mechanism by an initialism, the *ABEGHHK'tH mechanism*, in general. However, Higgs and Englert only won the 2013 Nobel Prize after the discovery of the Higgs particle (boson) in 2012 in CERN's Large Hadron Collider (LHC), popularised also as the “God particle.” This great discovery was achieved by the CMS and ATLAS⁷ collaboration teams, proving that Higgs bosons (H) emerge with a very high mass of around $126 \text{ GeV}/c^2$, accompanying the Higgs field that is responsible for the mechanism. It was necessary to assume such a field due to the thermodynamic point of view, which also explained the symmetry breaking reality of the universe between matter and anti-matter.⁸ The detection of these particles is so difficult due to their very fast decay in space, allowing them to exist only for less than a septillionth of a second.

We cannot face the weak and strong nuclear forces in everyday life because they eventuate within the nucleus. We do not feel their effects like gravity on Earth, the electrostatic effects with pieces of plastic and paper, or small magnets pulling the pins on our table. The requirement of the nuclear forces theoretically comes from the following fundamental question: If only electromagnetic interactions exist, how come the nuclei haven't fallen apart as they consist of protons and neutrons, while protons repel each other? The

⁵ S. Weinberg, “A Model of Leptons,” *Phys. Rev. Lett.* 19 (1967): 1264–66.

⁶ P. Higgs, “Broken Symmetries and the Masses of Gauge Bosons,” *Phys. Rev. Lett.*, 13 (1964): 508.

⁷ CMS Collaboration, “Observation of a New Boson at a Mass of 125 GeV with the CMS Experiment at the LHC,” *Physics Letters B*, 716 (2012): 30–61.

⁸ A very recent publication highlights the idea: P. Meade et al., “Unrestored Electroweak Symmetry,” *Phys. Rev. Lett.* (2019): 122.041802.

basic difference between strong and weak ones is that the first holds the nucleons together inside a nucleus and also explains the interactions between the subatomic particles (quarks) within a nucleon. The latter is the force that holds a nucleon before its β -decay⁹.

Strong nuclear force

Strong nuclear force has been theorised and became the basic principle of nuclear physics since the discovery of neutrons by Chadwick in 1932 and the later development of the theory of nucleon–nucleon interactions separately described by Heisenberg and Ivanenko. As shown in figure 4.1, the interaction is only active in an ultra-short range in the order of femto (10^{-15}) metres with a carrier interaction gauge boson called the *gluon*.¹⁰ The particle (gluon) field theory is theorised by Murray Gell-Mann in 1962 and the existence of gluons is proven by the PLUTO¹¹ experiments in 1978.

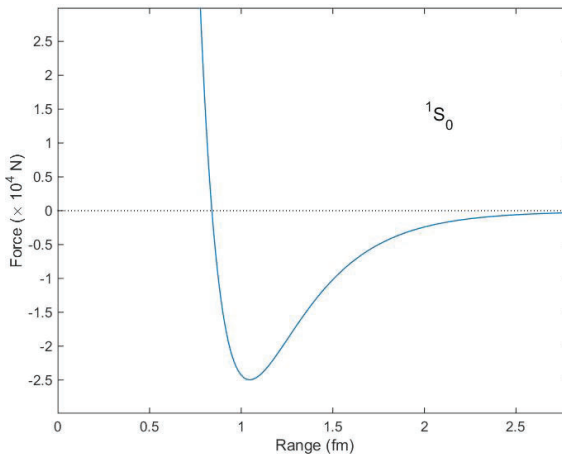

Figure 4.1. The nuclear force as a function of the nuclear range demonstrating the strongest binding around 1 fm.¹²

⁹ For further reading, see K. S. Krane, *Introductory Nuclear Physics* (Wiley, 1987).

¹⁰ Gluons can have an effect in the long range because they are massless. However, they are confined within the nucleus due to gluon–gluon interactions.

¹¹ A detector established at Deutsches Elektronen-Synchrotron (DESY) Labs in Germany, a German-British corporation.

¹² Reproduced after R. V. Reid, “Local Phenomenological Nucleon–Nucleon Potentials,” *Annals of Physics* 50 (1968): 411–48.

Elementary particles

Figure 4.2 illustrates a systematic diagram of the elementary particles, which have been experimentally observed up to now except for the graviton (G) situated in the last column of the table. It still remains hypothetical in the standard model (SM) due to the lack of experimental evidence. As seen in this table, we can generally classify the elementary particles as fermions with half spins¹³ obeying Fermi–Dirac statistics and bosons with integer spins obeying Bose–Einstein statistics. It is essentially considered that all the fermions (quarks and leptons) would also have an antipode of each, constituting matter and anti-matter.

Standard Model of Elementary Particles + Gravity

		three generations of matter (fermions)			interactions / force carriers (bosons)		
		I	II	III			
mass		+2.4 MeV/c ²	+1.275 GeV/c ²	+172.44 GeV/c ²	0	+125.09 GeV/c ²	0
charge		2/3	2/3	2/3	0	0	0
spin		1/2	1/2	1/2	1	1	2
		u up	c charm	t top	g gluon	H higgs	G graviton
	QUARKS	d down	s strange	b bottom	γ photon		
		+4.8 MeV/c ²	+95 MeV/c ²	+4.18 GeV/c ²	0		
		-1/3	-1/3	-1/3	0		
		1/2	1/2	1/2	1		
		e electron	μ muon	τ tau	Z Z boson		
	LEPTONS	+0.511 MeV/c ²	+105.67 MeV/c ²	+1.7768 GeV/c ²	+91.19 GeV/c ²		
		-1	-1	-1	0		
		1/2	1/2	1/2	1		
		ν_e electron neutrino	ν_μ muon neutrino	ν_τ tau neutrino	W W boson		
		+2.2 eV/c ²	+1.7 MeV/c ²	+15.5 MeV/c ²	+80.39 GeV/c ²		
		0	0	0	+1		
		1/2	1/2	1/2	1		

GAUGE BOSONS (VECTOR BOSONS)
 SCALAR BOSONS
 HYPOTHETICAL TENSOR BOSONS

Figure 4.2.¹⁴ Table of elementary particles; fermions and bosons. All are experimentally confirmed except for the hypothetical tensor boson graviton, G.

On the other hand, the bosons have no anti-particles and, some are considered to be the products (quantum fields) of the *symmetry breaking processes* that break the balance between particles and anti-particles in favour of particles, consequently allowing the existence of the normal baryonic matter. Of these, the ones on the first boson column (vector bosons) are called the force-carrying bosons that mediate three of the four interactions except gravitation. The production mechanisms of these force-

¹³ A full spin in 3D space corresponds to 4π or an angle of 720° , which is the full spin of an object in the x - y and y - z planes, respectively.

¹⁴ Work in the public domain.

carrying gauge bosons are shown in the following diagrams in figure 4.3 known as Feynman diagrams.¹⁵ All the diagrams have to consolidate the known conservation laws of physics, such as the conservation of energy, charge, angular momentum, and so on.

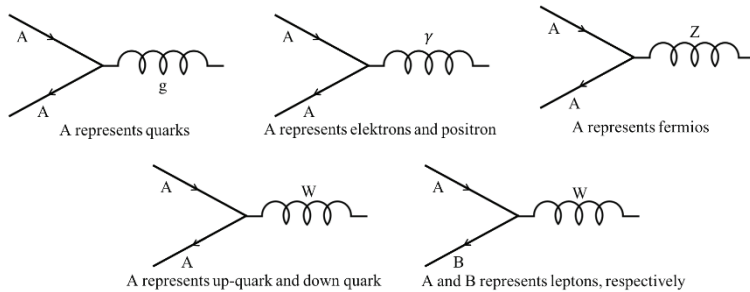

Figure 4.3. Production of the force-carrying gauge bosons shown by Feynman diagrams. They all appear from the virtual annihilations of the fermions (quarks and leptons).

These are the first-generation bosons that constitute the first-generation interactions directly known as the electromagnetic, strong, and weak fields. The reverse of these processes can also be considered. In this case, these processes would be called decay processes, producing the fermions. These processes are conceived from nuclei to electrons in an atom in order to follow the creation of matter and electromagnetic radiation. The W , Z , and g bosons decay into the quarks and leptons (fermions) and then the fermions decay into the γ -photons as shown in the fundamental processes of the SM in figure 4.4.

¹⁵ Feynman diagrams show the appearance of particles under a certain interaction. For further reading, see, for example, J. R. Brown, “How do Feynman Diagrams Work?,” *Perspectives on Science* 26, no. 4 (2018): 423.

Standard Model Interactions (Forces Mediated by Gauge Bosons)

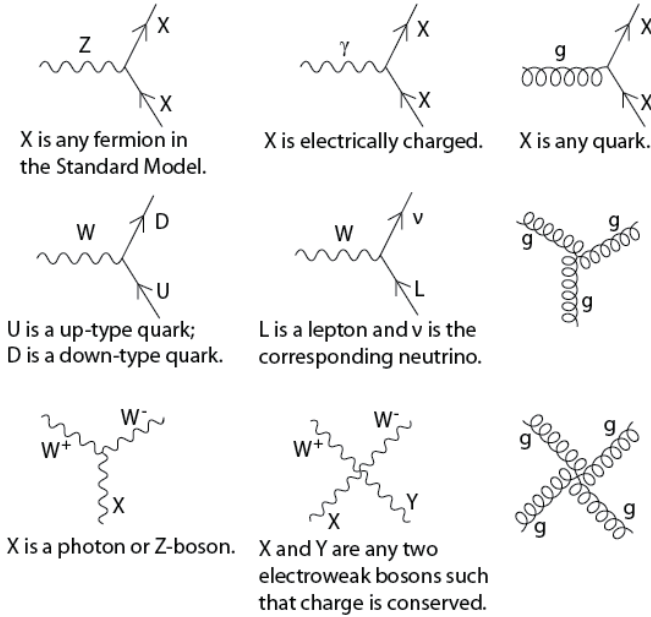

Figure 4.4. Possible generation mechanisms of the gauge bosons (g , γ , W and Z) of the three fundamental forces (except gravity) in the SM illustrated by Feynman diagrams.¹⁶

As is commonly known about the positive and negative charges of electromagnetism, there are also the charges of the other three interaction types in the SM of particle physics. According to the SM, interaction between the two species in space occurs when the two have the same kind of charge. A certain type of charge of a particle appears in the forms of electric charge, colour charge (strong charge), hypercharge/isospin charge (weak charge), and mass charge (inertial charge) that determine the role of participation in the interaction processes. These interaction processes respectively correspond to electromagnetic interaction, strong nuclear interaction, weak nuclear interaction, and gravity. Sub-atomic particles

¹⁶ Permission is granted to reproduce the figure under the terms of the GNU Free Documentation License.

known as leptons and quarks are the key elementary particles that provide three of the four kinds of charges except the mass charge, within any kind of particle or object. One important piece of the puzzle was missing on the sheet of the elementary particles and that was the Higgs (H) boson, which is responsible for the mass charge of the elementary particles; its appearance was proven by CERN's Large Hadron Collider. The gauge bosons can be produced by the annihilation of the same kind of particle–antiparticle collisions of leptons and quarks.

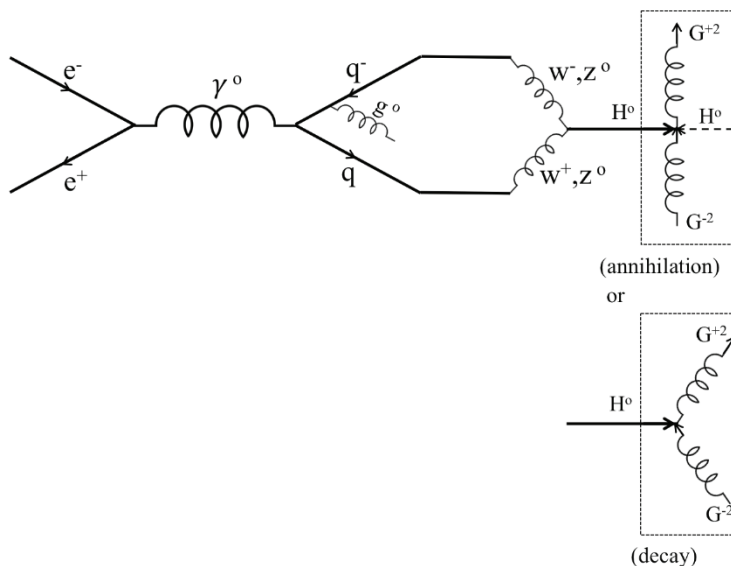

Figure 4.5. Three generations of force fields (γ , g , W - Z) and the probable fourth one (G).

The recently confirmed scalar Higgs boson on the second column of the bosons in figure 4.2 is rather second generation and is generated by the W and Z bosons as shown in the Feynman diagram in fig 4.5, as an outcome of the collisions of very energetic hadrons. The Higgs boson is a quantum of the Higgs field just as a photon is a quantum of the electromagnetic field. This second-generation process produces a rather hybrid interaction called *electroweak* symmetry breaking, which is responsible for the rest mass of the massive vector bosons (W - Z). Now, we come to the last but most mysterious column of the tensor boson, which has no experimental evidence whatsoever. In the hypothetical interpretation, it might be a third-generation

boson and can be produced in the Higgs process(es),¹⁷ decaying into the gravitons that mediate gravity, that are the quanta of the gravitational field.

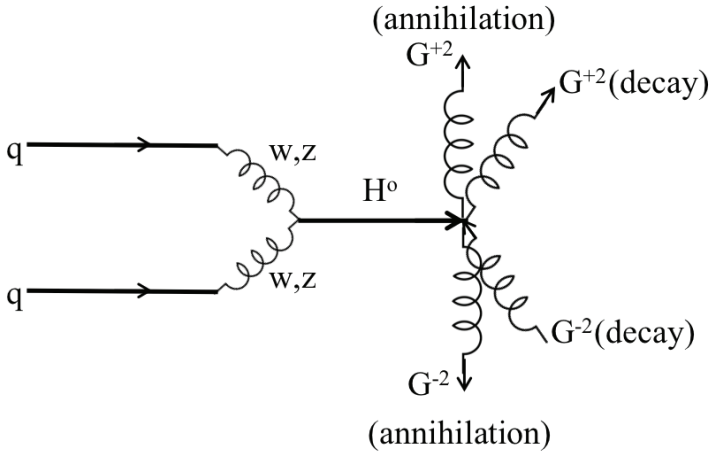

Figure 4.6. Predicted generation mechanism for the gravitons (G) that are hypothetically considered to mediate gravity.

As a demonstration of this decay or annihilation process, we show the hypothetical drawings displayed in figure 4.5 as a framed inset and re-illustrate them in figure 4.6. Although it would be very difficult to perform such experiments due to the unstableness of the Higgs bosons, it is theoretically a matter of showing the fact that any of the Higgs decay is capable of symmetrically breaking into the gravitational field.

¹⁷ S Tüzemen, “A Possible Microscopic Model for Gravitational Interaction,” *Physical Science International Journal* 9, no. 1 (2016): 1–6; S. Tüzemen, “Approaching to Gravity?” *Journal of Physics: Conference Series* 707, no. 1 (2016).

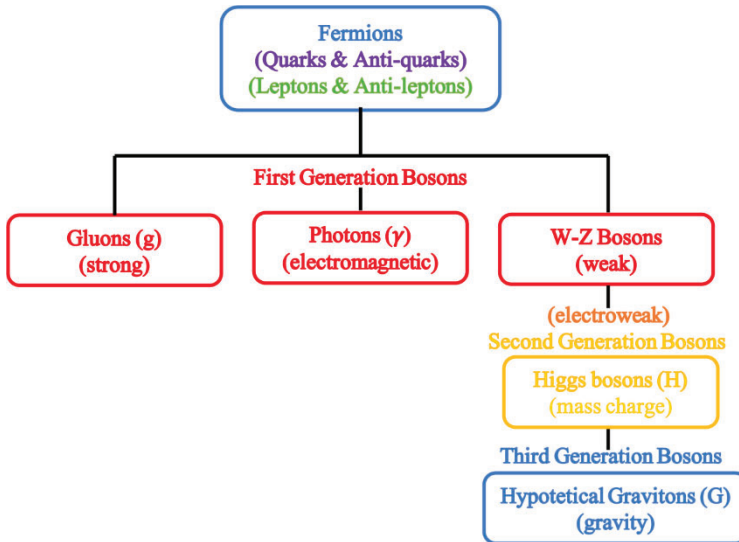

Figure 4.7. A block diagram summarising the hierarchy of the elementary particles that are all introduced in the four fundamental interactions. Colour coding of the diagram is the same as in figure 4.2.

Schematic illustrations of the summary of the above explanations are shown in figure 4.6 as a Feynman diagram and figure 4.7 as a block diagram. It is generally agreed that bosons have no anti-particles so that the decay process is more likely rather than that of the annihilation.

The presently known field of the gravitation is the tensor field of Einstein ascribed to the spacetime curvature in general relativity, which is a topological geometric field, refusing any kind of quantum particle of a quantum field. In fact, Einstein does not take it as a fourth force; instead, he considers it as an observational “error” or a “mistakenly felt perception” due to general relativity, which is explained in Chapter 2.

Propagation

Speaking from a non-relativistic point of view, it is a general consensus that all the physical effects propagate spherically unless they are restricted in one direction as in the case of lasers; a restricted status of the photon propagation, for instance. The spherical propagation of the fields results in the inverse square laws of physics such as Newton’s gravitational and Coulomb’s electrostatic forces since the total propagation of a particular

effect has to be divided by $A = 4\pi r^2$, the surface area of a sphere when the intensity of the effect is calculated in one particular direction:

$$[\textit{Intensity in } r \textit{ direction}] = \frac{[\textit{Total Spherical Distribution}]}{[\textit{Total Spherical Area, } 4\pi r^2]}$$

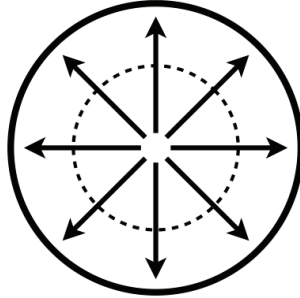

Figure 4.8. An illustration of the spherical distribution diverging from a point source.

The situation is illustrated in figure 4.8. In general, the spherical distribution that gives rise to the inverse square relation is true even in the propagation of earthquake waves, sound, light illumination, and so on; that is, their intensities diminish as you go further away from the source. The inverse square law is valid for the cases of photons and gravitons respectively in the long-range electromagnetic and gravitational interactions, rendering the classical Newton and Coulomb Laws valid. One important deviation between modern and classical thoughts is the fact that gravity and electromagnetism propagate with the speed of light (c) since, respectively, the gravitons and the photons mediate with the speed of c , while Newton and Coulomb predict propagation with infinite velocities.

On the other hand, the idea of the distant spherical distribution wouldn't be valid when certain quantum mechanical restrictions come into play. These interdictions can be the quantum confinement as in the cases of the gluon–gluon interactions and the heavy W – Z bosons, which constitute the strong and weak nuclear forces, respectively. These particular constraints provide nuclear interactions to take place only within the nuclei in the orders of femto-metres. As I explained earlier, the interaction bosons in the SM are classified as the vector bosons with a spin of 1 (the photons in the electromagnetic, the W – Z bosons in the electroweak and the gluons in the strong interactions) and the tensor bosons with a spin of 2 (the hypothetical gravitons in gravity).

Of these interaction bosons, the massless ones—the photons and the gravitons—obey the inverse square law for the long-range effects, propagating with the speed of light. The gluons are supposed to propagate with the speed of light due to their massless feature, however, they cannot decouple because of the quantum confinement that sticks (glues) them together within the nuclei called gluon–gluon interaction. This causes a rapid exponential drop of the effect as a function of $\exp(-\mu r)$, restricting its intercourse within the nuclei. The actors of the weak interaction, the W – Z bosons, are massive and can only have a decay causing nuclear fissions, or they will otherwise provide nuclear bonds between the nucleons. The photon is a vector boson and causes the vector fields as in the case of electromagnetism (\mathbf{E} and \mathbf{B}), while, on the other hand, the hypothetical tensor boson, the graviton, gives the tensor field ($\mathbf{T}_{\mu\nu}$), as in the case of general relativity.

The other type of boson with zero spin is the scalar one that does not play a direct role in the four interactions and is currently known as the Higgs boson. This is a scalar field of Higgs and is responsible for the scalar mass of the W – Z bosons, keeping them within the nucleons. A symmetry breaking process eventuates with the replacement of the massless photons of the electromagnetic interaction with the massive W – Z bosons of the weak interaction involving the scalar mass field of Higgs. The two are collected under one roof, called *electroweak interaction*. This situation in fact originates from superconductivity when the electron–electron coupling is explained. The details of this interaction will be given in Chapter 7.

Interaction of quarks: fundamental interaction

In this section, we will look at the interaction of quarks that combine to constitute composite particles such as protons, neutrons, and mesons, generally called *hadrons*. As can be seen from the elementary particles table in figure 4.2, quarks have six different types called flavours: up (u), down (d), charm (c), strange (s), top (t), and bottom (b) quarks. The combination of these quarks confined in a bundle of hadrons is only possible with the type of strong nuclear interaction normally called *fundamental strong interaction* that mediates gluons between the quarks. According to the quark model, there are two different types of this combination: the first is bosons consisting of two quarks called *mesons*, and the latter is fermions consisting of three quarks called baryons. Neutrons (*udd*) and protons (*uud*) are the baryonic hadrons, and therefore atoms and molecules and consequently known matter are constituted on the bases of these hadrons, called *baryonic material*.

The (udd) and the (uud) combinations of, respectively, neutrons and protons are good enough to explain the spin and charges of these hadrons. However, one important problem appears in terms of the Pauli Exclusion Principle, because the two (dd) or (uu) pairs should have the same spin down or up character. The problem was solved by Greenberg, who introduced the “colour states” (red, green, blue, and their anti-colours) for each pairs defined by different quantum numbers,¹⁸ shortly after the invention of the quark model by Gell-Mann in 1964. The whole story is more complicated than that, but simply the exchange of gluons changes the colours of quarks allowing them to “strongly” interact to constitute a hadron. The entire mechanism is encapsulated by the term *Quantum Chromodynamics*—QCD.

In QCD, each individual quark is colourless or in the degenerate white colour having the quantum states of red, green, and blue, or their anti-colours. However, when they bind together to be confined within a meson or a baryon (proton or neutron) they should indicate their colours. It is just the appearance of new quantum states when the particles are confined as shown in figure 3.6(c) of Chapter 3. As mesons have two quarks confined inside, they can have each of the three colours, but they should be the opposites of each other. As hadrons consist of three confined quarks, each quark can be in any colour provided they don’t simultaneously have the same colour charge states, in order not to violate the Pauli exclusion principle.

It has been pointed out that the flavour isn’t enough to secure the Pauli exclusion principle since the two quarks in the uud , udd , or uuu combinations of hadrons would have the same states within a hadron. There should be another indicator that provides the quarks at different states, which is the colour state. This colour difference results in different quantum states of nuclei and leads to the interaction between the hadrons specifically called *strong interaction*. What is being affected in strong interaction is what provides the difference between the quarks within the hadrons: the colours. That is why the interaction charge in the fundamental strong interaction is named *colour charge*. Just as the positive and negative charges of electromagnetism quantise the electronic energy levels in the electromagnetic interaction of protons and electrons in atoms, the colour charges of the nuclear interaction quantise the nuclear energy levels in hadrons and consequently in nuclei.

¹⁸ For further reading, see B. H. Bransden and C. J. Joachain, *Introduction to Quantum Mechanics* (Longman, 1989), 453.

In terms of the mass production of hadrons, for example, protons are composite particles formed by confining the two up and one down quarks in the strong interaction with the gluons, constituting the electrical charge of a proton as $(2e/3 + 2e/3 - 1e/3 = 1e)$. However, the total mass of the quarks is only 10% of the proton mass. The remaining 90% is compensated for by the kinetic energy of the quarks before, and the binding energies of the quarks after, the confinement. All the processes taking place within protons and neutrons are called *chromodynamic* or *flavourdynamic* processes, referring to colours and the six types of flavours of the quarks (up, down, charm, strange, top, bottom) rendering the *Pauli exclusion principle* as described earlier in Chapter 3.

The question of how neutrons and protons are held together to form nuclei can also be explained by the strong interaction with the exchange of a meson called the π -meson; the pion (π^0), which is also mediated by the gluons. This type of interaction is called *residual strong force*; it will be explained in the interaction of hadrons.

Interaction of hadrons: residual and weak interactions

A nucleus consists of positive protons and neutral neutrons that are generally called nucleons. To keep these nucleons together, overcoming the electromagnetic repulsion of protons, we have to have a stronger attraction force in short distances around the radius of a proton. This is the other type of the strong nuclear force, called the “residual strong nuclear force,” and it happens between the nucleons. The strong nuclear force eventuates between the quarks within the hadrons as has been explained in the previous section, but this type is given the term *fundamental*, differentiating it from the one termed *residual* in various aspects such as interaction species.

One of the most explicit differences between residual and fundamental interactions is that there needs to be something to trigger the residual strong nuclear force between the nucleons to overcome electromagnetic repulsion. This intermediary role is consolidated by the weak interaction, changing the flavour of the quarks from up to down or vice versa, converting protons to neutrons or the reverse, with a process called *beta-decay*.

The weak interaction is the base of the beta-decay releasing an electron (or positron) and anti-neutrino from the nucleon, converting it from one to the other, which was first explained by Fermi in 1930. You can simply think of this as a neutron that releases a negative electron, transforming itself into a proton or a proton that releases a positron converting it into a neutron. However, this doesn't mean that the electron is a component of a neutron, or a positron is a component of a proton. This is just a nuclear reaction

triggered by the weak force, involving W - Z heavy bosons, which ensures it happens only in a very short range in the order of femto-metres, the scale of a proton or neutron.

This is also important for nuclear fusion to happen, which is the basic event in the sun and stars that leads them to burn and give energy out. The H - H coupling is normally impossible in terms of electromagnetic interaction. However, the weak interaction allows it to happen by the spontaneous change of proton to neutron and vice versa and, eventually the strong interaction allows unstable He^2 to exist. Further fusions due to the weak interaction with neutrons sequentially produce He^3 and finally the stable He^4 . Just as the gluons changing the colours of the quarks provides the strong interaction possible between the quarks, weak interaction changes the flavours of quarks providing strong interaction between the nucleons.

Flavour changes of the quarks may result in parity changes from positive to neutral or neutral to positive or they may preserve the parity. To have these three situations, the gauge bosons of the weak interaction should be in the three charge states as the W^+ , W^- and Z^0 bosons are.

Generation of matter and the cosmos

All the elementary particles on the table of the SM shown in figure 4.4 are experimentally confirmed except for the graviton (G) placed in the last column. This was hypothetically included in the table of the elementary particles, in order to explain the gravitation. The table is, so to say, like a periodic table of elements in chemistry indicating all the features of the elementary particles and consists of two parts as the fermions with half spin and the bosons with full, zero, or two spins. Essentially the fermions are responsible for the generation of the baryonic hadrons (protons and neutrons), and consequently the nucleus, using the nuclear forces with the four interaction bosons (gluon, W^\pm , and Z^0) and eventually atoms (normal baryonic matter), using photons as the interaction bosons. Finally the hypothetical gravitons or the fields of the spacetime curvature are responsible for the fourth interaction, the weakest gravity.

There are essentially two types of strong nuclear interaction: the interaction of quarks within the nucleons (protons and neutrons) and the interaction of nucleons within the nuclei, all involving gluons. Weak interaction is like a *pion* interaction changing a proton to a neutron and called *flavour changing*, allowing the neutron to interact with the proton. In the strong interaction between a proton and a neutron, the virtual pion exchange is effective. This process repeats (swaps) itself every 10^{-24} s by virtue of the virtual heavy gauge bosons (W - Z bosons) of the weak

interaction having masses of around $90 \text{ GeV}/c^2$, which decay in very short times due to their mass according to the energy-time version of Heisenberg's uncertainty principle (HUP). Here, energy is the equivalent mass energy of the massive $W-Z$ bosons and time is the division of Planck constant by this energy.

The weak interaction process, in a way, has a unique behaviour in the sense that it breaks “parity symmetry” going from positive to neutral (not negative). On the other hand, the weak force doesn't involve any kinds of potential energy in the sense that gravity, electromagnetism, and/or the strong interaction they have bind together, respectively, the objects, atoms and molecules, nucleons, and nuclei. This is one of the reasons why it is called *weak*, although it is responsible for the nuclear reactions.

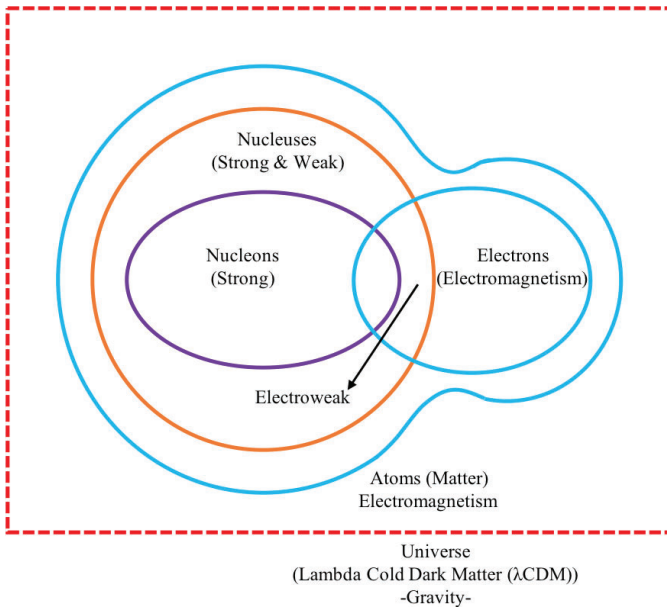

Figure 4.10. Schematic diagram illustrating the formation of the cosmos with the four known interactions. Colours show the weakest to the strongest just as the photon energies increase from red to purple.

Neutrons are constituted, due to weak interaction, as known from the nuclear “ β^- -decay of neutrons,” allowing neutron–proton strong interactions in order to overcome the proton–proton electromagnetic repulsion within nuclei. However, this process needs the inclusion of massive $W-Z$ bosons

by breaking the electromagnetic symmetry into the electroweak symmetry involving the *Higgs mechanism*, which will be explained in Chapter 6.

The construction of atoms and molecules is purely due to electromagnetic interaction involving the virtual photons as mediating gauge bosons. On the other hand, the interatomic and intermolecular bindings constituting the known baryonic matter are also due to electromagnetic interaction. The final leg of the interactions is the gravity involving hypothetical bosons of gravitons, which is responsible for holding the whole universe within the spacetime fabric or lattice. Figure 4.10 schematically illustrates the appearance of nucleuses, atoms, matter, and eventually the universe with the involvement of the four fundamental forces.

One interesting aspect to notice is that the interaction forces weaken as we go from nucleons to nuclei to atoms and molecules, and finally to the interaction between masses of objects (gravity). This property is labelled with the colour code from red to purple in figure 4.10. The strength of the interaction forces can be sorted out from the strongest to the weakest as follows: the fundamental strong nuclear (nucleons), residual (nuclei), electromagnetic (atoms and molecules), weak (intermediary between nucleons) interactions, and gravity (whole cosmos). This is because the higher the strength (binding energy) the higher the critical temperature at which a particular interaction was able to eventuate as the universe was gradually cooling from its magnificent expansion after the Big Bang. This explains the chronological order of the creation, which is roughly sorted as elementary particles, nucleons, nuclei, atoms, molecules, matter, and cosmos.

Couplings

The known fundamental forces are summarised in table 4.1. Strengths of the forces relative to each other are structured by the intensities of the virtual gauge bosons propagated due to the quantum fields. This situation between electromagnetism and gravity is explained in Chapter 6.

As can be seen from the fundamental interaction table, the gravity acts on mass and light (according to general relativity) and allows the hypothetical gravitons to interact. The next interaction is the weak interaction responsible for the flavour transformation of quarks, mediating the heavy W - Z bosons explained by the symmetry breaking mechanism of Higgs, giving rise to the “mass term” in the field equations. On the other hand, the best-known electromagnetism is responsible for the quantisation of atoms and molecules by mediating the virtual photons as the electromagnetic interaction bosons, and can be unified with the weak

interaction under the roof of the electroweak theory combining the symmetry groups. Finally the strongest one, the strong nuclear interaction using the gluons is termed *fundamental* between the quarks within hadrons (nucleons and mesons) or *residual* between the nucleons (protons and neutrons) within nuclei.

Table 4.1. A summary of the properties of four fundamental forces.

Type of interaction and strength	Mediating particles (gauge bosons)	Actors	Dependents	Generations
Gravitation (10^{-36} at the scale of nucleons)	Hypothetical Massless gravitons (G)	Mass	Mass and light	Spacetime Fabric (whole universe)
Weak (10^{-7} at the scale of nucleons)	Heavy W-Z bosons	Flavours of quarks	Quarks and leptons (antipode of them excluded)	Neutrons and nuclear reactions
Electromagnetic (1)	Massless photons (γ)	Electrical charges (Q)	Electrical charges (Q)	Atoms and molecules
Strong fundamental (60 at the scale of quarks)	Massless gluons (g)	Colours of quarks	Quarks and gluons	Hadrons (nucleons and mesons)
Strong residual (20 at the scale of nucleons)	Gluons with the assistance of virtual pions	Flavours and colours of quarks	Hadrons (proton and neutron)	Nuclei

The strength ratios of the interactions given in table 4.1 with respect to each other are calculated by comparison with the coupling constants on the bases of electromagnetic energy of a photon of ν frequency corresponding to a wavelength of λ , which is given as

$$E_\nu = h\nu = \frac{hc}{\lambda} \quad (4.1)$$

It is a general consensus that photons can interact with systems having sizes in the order of its wavelength. For example, X-rays interact with crystals because their wavelengths are in the order of the crystal parameter. Infrared has the “local vibrational modes” of a defect and the same is true of many other examples. Therefore, the comparison of the certain interactions of a system is done with respect to a photon energy with a wavelength in the order of the diameter of this particular system that is likely to couple with the photon’s field. The ratio eventually gives the dimensionless coupling constants of each interaction.

For example, the ratio (or normalisation) of gravitational interaction of a proton–proton system of r diameter with respect to the photon energy with a wavelength of $\lambda = 2\pi r$ gives the dimensionless gravitational coupling constant of

$$\alpha_g = \frac{Gm_p^2/r}{hc/2\pi r} = \frac{Gm_p^2}{\hbar c} \approx 5.9 \times 10^{-39} \quad (4.2)$$

where G is the gravitational constant, m_p the proton's mass, and the others are previously defined.

The same calculation for electromagnetism, i.e., the normalisation of the electromagnetic interaction with respect to the photon energy gives the dimensionless electromagnetic coupling constant, which is also called the “fine structure constant,” given as

$$\alpha = \frac{e^2}{4\pi\epsilon_0\hbar c} \approx 0.0073 \quad (4.3)$$

where e is the electron charge and ϵ_0 the electrical permittivity of free space. The ratio between the two coupling constants of the two interactions (electromagnetic and gravitation) is given as

$$\frac{\alpha}{\alpha_g} \sim 10^{36} \quad (4.4)$$

which is the strength ratio between the electromagnetic and gravitational interactions given in Table 4.1. All the other ratios between the electromagnetic, weak, and strong interactions are a little more complicated than this involving some unconventional equations and interaction charges of the weak and strong forces; however, they are calculated with the same method.

CHAPTER FIVE

QUANTUM FIELDS

“Nobody ever figures out what life is all about, and it doesn’t matter. Explore the world. Nearly everything is really interesting if you go into it deeply enough.”
—Richard P. Feynman



Photograph of Richard Feynman, taken in 1984.¹

As described by Richard Feynman, we will now explore and look at the interesting transformations of the *quantum fields* that break the symmetry of the universe, as we go into the details of the interaction forces explained in Chapter 4. They all appear from quantum fluctuations predicted by Heisenberg’s uncertainty principle (HUP). These symmetry breaking

¹ Courtesy of Tamiko Thiel.

transformations, or you may prefer to say “transactions,” transact the cosmos in favour of matter as they have an initial symmetry with anti-matter. These crucial processes prevent the self-destruction of the cosmos, allowing it to look like the present observable universe.

This is really one of the vital secret codes of God, which was hacked by human beings, after the discovery and development of quantum mechanics, in the mid-twentieth century. The quantum mechanical implications are initiated with a theory called *symmetry breaking gauge theory*, referring to gauge bosons. They appear due to quantum fluctuations in the known physical interactions that at the moment are recognised to be four kinds, as was explained in the previous chapter.

In this chapter, we shall try to understand the quantum fields briefly without entering into the theory too much, following the conceptual concerns of this book and combining all the main issues explained earlier.

General overview

When the quantum fields couple with the elementary particles, if they have a coupling constant for a certain quantity such as mass, charge, and so on, they gain those particular quantities. For example, the electric charge is a sort of coupling constant of the electromagnetic field. On the other hand, a certain amount of mass is given to a certain elementary particle because there exists a coupling constant of a field called the Higgs field.

Quantum field theory (QFT) is based on gauge theory using the relativistic forms of Schrödinger equations, called Klein–Gordon equations in Lagrangian (\mathcal{L}) form, rather than in the conventional Hamiltonian (\mathcal{H}) one. It shows that different quantum fields appear in different symmetry breaking processes called *spontaneous symmetry breaking*, under which \mathcal{L} remains invariant. These processes are named as the Lagrangian invariant transformations. I liken these transformations to wooden Matryoshka dolls (also known as Russian stacking dolls) in which as you go in further they remain invariant (as in the case of the Lagrangian remaining invariant), but they come out from the one previous in decreasing sizes (as in the case of reducing or broken symmetries).

All the extracted fields except for the gravitational one are experimentally proven mainly in CERNs Large Hadron Collider (LHC). The last one, for instance, appeared, recently in 2012 as the Higgs’s particle, also publicly called the “God particle.” The whole theory came from quantum electrodynamics (QED) and quantum field theory (QFT) and was advanced by gauge theory and the standard model (SM). Finally with the involvement of gravity including also Einstein’s general relativity theory, it is all bound

together in the theory of everything. I do not intend to give the whole history but the brief chronological and hierarchical development is shown in the schematic diagram of table 5.1.

Table 5.1. Block diagram illustrating the general overview of the development of the theory of quantum fields.

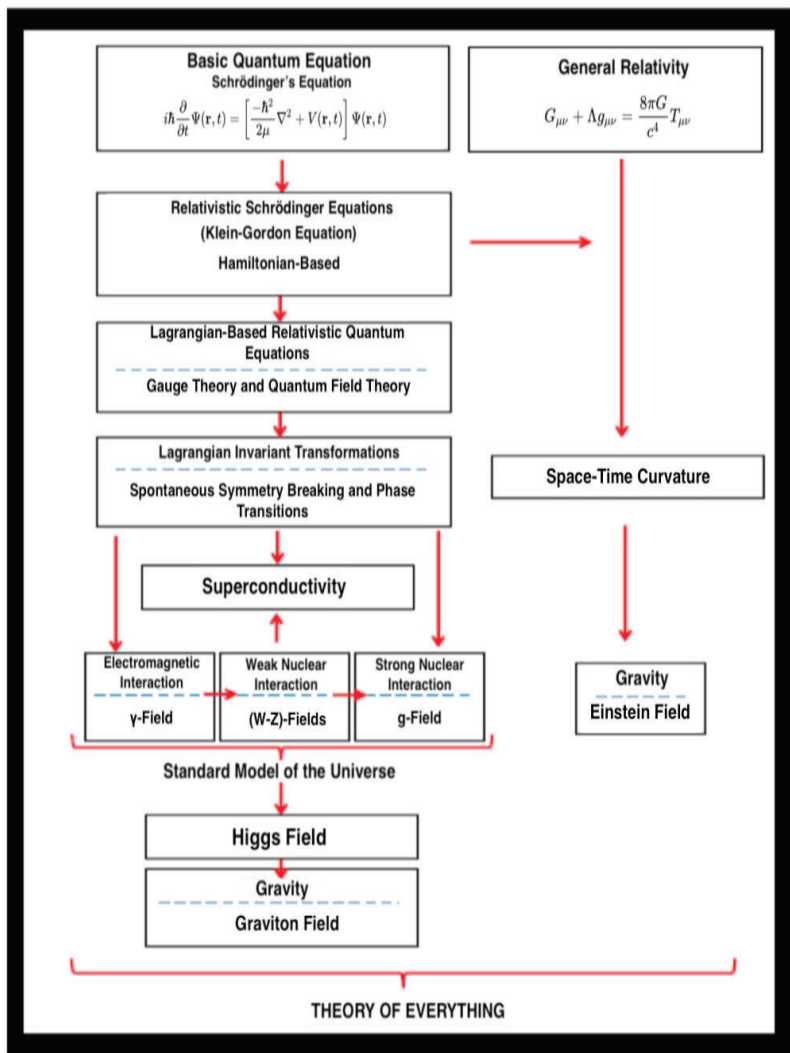

Basic quantum predictions

In this part of the chapter, we will try to explain the adventure of quantum mechanics from Schrödinger to Klein–Gordon, constituting gauge theory and eventually explaining the spontaneous symmetry breaking processes in the universe. Spontaneous symmetry breaking is of importance in terms of understanding all the known forces governing the production of matter and consequently the formation of the universe.

As I explained earlier, the quantum fields are created from one another, like Russian Matryoshka dolls, by the symmetry breaking processes without any transformation in the Lagrangian, that is, without violating the conservation of energy. We will see that each transaction happens at a particular temperature so that it is a sort of phase transformation of the universe establishing the concordance and harmony between the cosmological systems.

As also expressed previously in Chapter 3, the stationary-state² Schrödinger equation describes the quantum mechanical wave mechanics of the system with the quantum energy state E , and can be written as follows

$$\left[-\frac{\hbar^2}{2m} \nabla^2 + V(\mathbf{r}) \right] \psi(\mathbf{r}) = E\psi(\mathbf{r}) \quad (5.1)$$

for a particle with a mass of m , being under the potential of $V(\mathbf{r})$. The term in the bracket on the left is called the Hamiltonian, \mathcal{H} . The solutions of the Schrödinger equation established for a quantum mechanical system are very useful because the accompanying wave functions $\psi(\mathbf{r})$ explain all the probabilities being at a position of \mathbf{r} and at an energy level of E . However, the Schrödinger equation is not enough to express the symmetry breaking processes of QED mentioned here and earlier.

Instead, we need the relativistic equations constructed by Klein and Gordon using also the Hamiltonian. The Schrödinger equation might well be applied for a stationary atom or molecule. However, it cannot be fully applied to an elementary particle (fermion or boson) quantised due to quantum fluctuations according to the HUP. Therefore, relativistic approaches are necessary, in this case. In the relativistic case of the particle physics, using the relativistic total energy equation

$$E^2 = p^2 c^2 + (m_0 c^2)^2 \quad (5.2)$$

and introducing the D'Alembertian operator \square^2

² All the atoms and molecules and any other quantum mechanical systems are considered to be in a stationary state as long as \mathbf{r} remains unchanged as a function of time.

$$\square^2 = \nabla^2 - \frac{1}{c^2} \frac{\partial^2}{\partial t^2} \quad (5.3)$$

which is adopted from the Laplace operator ∇^2 , with the inclusion of time as a dimension in non-Euclidian Einstein–Minkovski space for relativistic cases.

We can rearrange the Schrödinger equation of (5.1) as follows, in the relativistic case of free particles, for $V = m_0 c^2$,

$$(\square^2 - 2 \frac{m_0^2 c^2}{\hbar^2}) \Phi = 0 \quad (5.4)$$

which is called the Klein–Gordon equation³ for a free relativistic particle, where Φ represents the real quantum fields, that is, the gauge bosons. For zero-mass, it can be shown that equation (5.4) reduces a wave equation

$$\nabla^2 \Phi = \frac{1}{c^2} \frac{\partial^2}{\partial t^2} \Phi \quad (5.5)$$

which is exactly in the form of the electromagnetic wave equation having a speed of c . This indicates the fact that Φ represents the fields propagating with the speed of light, which are the gauge bosons of electromagnetic interaction—photons for instance. Then, the wave function Φ is not a wave function anymore, but reinterpreted as a field. As is well known, in electromagnetic radiation, the electrical (\mathbf{E}) and magnetic (\mathbf{B}) vector fields propagate with the speed of light and are replaced by Φ in equation (5.5), representing one of the vector bosons (photons) in the elementary particles' table shown in figure 4.2 of the previous chapter.

The equation applies to the other massless boson, the gluon (g), which can propagate with the speed of light. However, they are stacked within the nucleus due to the g – g interactions, as mentioned before. Using equation (5.1) based on the Hamiltonian, we have found out the only field related to the electromagnetic interaction that is quantised as a boson of photon. The Hamiltonian has the unitary (U) symmetry, which is symmetrical for all kinds of operations at every point of spacetime. In order to find out the other quantum fields that quantise different kinds of bosons, we have to discover what other symmetry operations are possible, rendering the energy conservation. For this kind of utility, the situation must be very constrained.

For all the quantum states, the Hamiltonian, $\mathcal{H} = K + V$ has got to be invariant because of the conservation of energy. However, the Lagrangian, $\mathcal{L} = K - V$ is not invariant for all the energy states. It is invariant only in the symmetrical states. On the other hand, if we can find the different

³ Detailed extraction is not given for the conceptual concerns. For further reading, see, B. I. Semoradova, “Quantum Mechanics of Klein–Gordon Equation” (master’s thesis, Czech Technical University in Prague, 2016).

quantum states at which \mathcal{L} remains invariant, then we call these sets of states the *symmetry groups*. Therefore, quantum mechanical wave equations using the Lagrangian rather than using the Hamiltonian one are preferred because they can sort out the symmetry groups. This method of theoretical physics is very useful in terms of finding out the quantised fields of particle physics, that is, the gauge bosons. Therefore, the theory is called gauge theory, which is probably the most fundamental in terms of sorting out the “quantum and cosmic codes of the universe.”

Brief introduction to gauge theory

The symmetry groups are in general classified as global and local. The Lagrangians that are invariant under some symmetry transformation groups describe many powerful theories in physics, rather than the Hamiltonians used in conventional quantum mechanics. Solutions for the Hamiltonian groups might be invariant under a transformation identically performed at every point in spacetime in which the physical processes occur. They are said to have a *global symmetry*. However, the Lagrangians, which have *local symmetries*, which involve only certain spacetime points under particular symmetry operations, are the cornerstones of gauge theories, since they would be more selective and deterministic because of their stronger constraint nature.

Gauge theory is an important backbone of theoretical physics that started with QED and eventually reached maturity with QFT and the SM. The theory is methodised from the quantum predictions briefly explained above, measuring (gauging) the Lagrangian invariant transformations which are said to be symmetrical. The fields included in the Lagrangian providing they are invariant are called the *gauge fields*, the quantisation of which are called *gauge bosons* of the elementary particles, consisting of the quantum fields of the SM.

Gauge theories can be built upon as successful field theories with the inclusion of fields into the Lagrangians of a sub-atomic particle system (basically fermions) in order to discover the outcome of the (quantised) fields (basically bosons), explaining the whole dynamics of the elementary particles given in figure 4.2. For example, one commutative (Abelian) symmetry group of QED is a gauge theory with the “unitary (U) symmetry group” $U(1)^4$ that has one vector gauge field quantised as the photon being the gauge boson of the electromagnetic interaction. The standard model, on

⁴ See Lie groups for further reading, A. Kirillov, “Introduction to Lie Groups and Lie Algebras,” SUNY at Stony Brook, New York.

the other hand, is a non-commutative (non-Abelian) gauge theory involving also the special unitary (SU) symmetry groups [$U(1) \times SU(2) \times SU(3)$] of the vector gauge fields quantised as the gauge bosons: the photon, the W - Z massive bosons, and the gluons of the electroweak and strong nuclear interactions. All these are tabulated in the elementary particles table, as in figure 4.2, shown in the previous chapter.

It has been shown that gauge theory can be established for various massless quantum fields that have the same Lagrangian as in the case of the photons and the gluons of the electromagnetic and strong nuclear interactions, respectively. However, in the case of the massive interaction fields of the W - Z bosons in the electroweak interaction, a massive scalar field of the Higgs boson had to be introduced by Higgs in the famous symmetry breaking mechanism called the Higgs mechanism.

The mechanism originally started with the understanding of *superconductivity* in which the question raised was, How come electron coupling is possible as they electrostatically repel each other? The answers came from the quantum mechanical implications, illustrating that it is possible in the symmetry breaking process transferring the system to a different kind of quantum phase (superconductivity), below a certain temperature, the so-called critical temperature. This is eventually adopted to understand proton-proton interactions within the nuclei, explaining the weak nuclear interaction as the proton-(W/Z)-proton, which is a symmetry breaking process transformed after the proton-proton electrostatic interaction. All the interactions are later combined under the roof of the electroweak theory of Abdus Salam and other groups. The unification of the fundamental forces are still of interest in the research area of theoretical physics.

Although the quantised gauge field giving rise to the gravitational interaction is experimentally unknown, a tensor field is theoretically introduced as a gauge boson called the *graviton*, which explains gravitation in the theory of general relativity studied under theories of *quantum gravity*. Its case is somewhat unusual in the sense that the gauge field is a tensor and what kinds of mechanisms can result in such a tensor field are still mysterious and open to new research areas. However, a simple prediction is underway in the further predictions of the next chapter on the standard model of the universe.

Understanding gauge theory

In order to understand particle physics and quantum fields, we have to accept the following postulates:

- (1) All the elementary particles of physics have to be handled with relativistic quantum mechanics (RQM), since they cannot be considered stationary. Even if they are positioned at a particular point, they fiddle around according to the HUP.
- (2) Using the Lagrangian operator rather than the Hamiltonian in quantum mechanical formulations is much more useful to find out the symmetry groups of the quantum states. This methodology of quantum physics is called gauge theory in general aspects.
- (3) In gauge theory, the quantum states turn out to be quantum fields, which represent certain bosons as an outcome of the fundamental interactions.
- (4) These bosons are the gauge bosons that mediate the fundamental interactions between the elementary particles.
- (5) New generation of particles may occur in various phase transitions with the Lagrangian invariant processes, which are called spontaneous symmetry breaking processes.
- (6) The spontaneous symmetry breaking processes occasionally result in lower energy states. This requires a new generation field representing a boson with a mass of M equivalent to energy difference between the previous energy state and the lower energy taken after the symmetry breaking, in order to consolidate the Lagrangian invariance, which insures also the conservation of energy.

In fact, the Higgs bosons were predicted by such considerations, explanation of which resulted in the Higgs mechanism invoking a new generation field of Higgs in the symmetry breaking process of electroweak interaction. The gauge bosons of this process are the massive $W-Z$ bosons that have a mass due to the Higgs field representing massive Higgs bosons with a mass of $M=125 \text{ GeV}/c^2$.

The entire explanation of gauge theories together with the experimental tests of the exiting bosons explain well three of the four fundamental forces establishing the SM of particle physics, which will be the next issue. The fourth interaction, which is not in the SM, is gravity that is hypothetically mediated by a gauge boson called the graviton. The mechanisms on the existence of a graviton are still mysterious but it will also be discussed in the next chapter.

Gauge bosons: force carriers

For a long time after the recognition of Heisenberg's uncertainty principle, it wasn't realised that this principle would result in the extraordinary *quantum fields* of physics due to quantum fluctuations. It was postulated in the standard model (SM) of the universe that these fields explain the contactless interactions of the four fundamental forces. Gravity and electromagnetism were well-known effects since the laws of Newton and Coulomb dating back to the eighteenth century; nevertheless, how the interactions between the two masses or charges causally take place without contact were not understood at all.

It is well established by the SM that the gauge bosons; the photons, the W–Z bosons and the gluons (g) perfectly explain three of the presently known four interaction forces: the electromagnetic, weak, and strong nuclear interactions except for gravitation. Gravitons (G) needed to be theoretically involved in the theory of everything (TOE), filling the fourth corner stone of the SM in the grand unified theory (GUT).⁵ The TOE reduces to Einstein's general relativity and Newton's gravitational law in the classical and weak field limit as described by Feynman et al.⁶

According to the SM, the interaction between the two species in space occurs when the two have the same kind of charge. These interaction processes and charges are explained in the previous chapter. Sub-atomic particles known as leptons and quarks are the key elementary particles that provide three of the four kinds of charges, except the mass charge, within any kind of particle or object. One important piece of the puzzle was missing on the chart of elementary particles and that was the Higgs boson, which is responsible for the mass charge of the elementary particles. This was proven to appear using CERN's Large Hadron Collider, shown in the photograph overleaf. The gauge bosons are produced by the annihilation of the same kind of particle–antiparticle collisions of leptons and quarks that are shown in figure 4.3 in the previous chapter.

⁵ H. Georgi and S. L. Glashow, "Unity of All Elementary-Particle Forces," *Phys. Rev. Lett.* 32 (1974): 438–41.

⁶ R. P. Feynman, F. B. Morinigo, W. G. Wagner, and B. Hatfield, *Feynman Lectures on Gravitation* (Addison-Wesley, 1995).

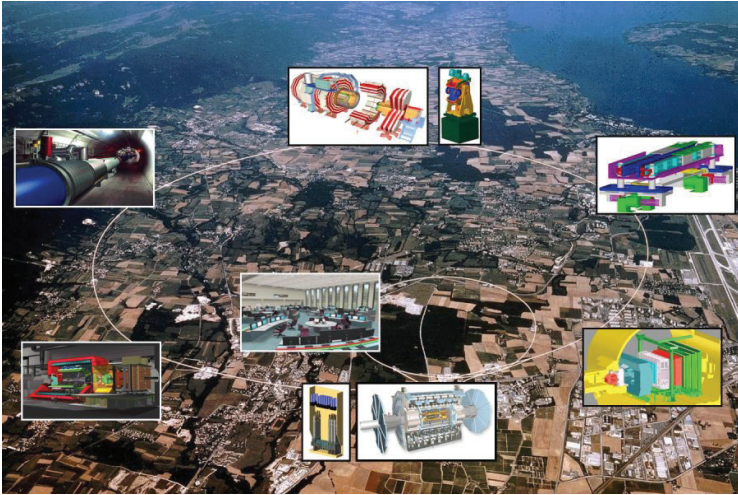

The photograph shows the 27-km diameter circle of CERN's LHC in Geneva involving particle accelerators, cyclotrons, synchrotrons, and detectors, colliding particles to create what is probably a small-scale version of the conditions of the Big Bang.

CHAPTER SIX

BASICS OF THE STANDARD MODEL

“Quantum theories are built up from physical concepts which cannot be explained in words at all.”
— Paul Dirac

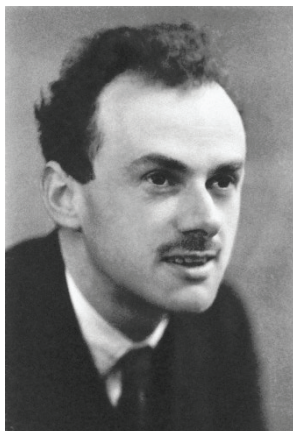

British physicist Paul Dirac, photographed in 1933,¹ received the Nobel Prize in the same year.

As the founder of quantum electrodynamics, this chapter’s first page is dedicated to Paul Dirac because his studies and notations in quantum theory provided a great insight for quantum field theory and the standard model. The silent man of quantum physics did not like to speak in words, as can be understood from his sayings, one of which appears above. He is also famous for saying “just shut up and calculate” on the conflicted discussions over quantum mechanics. In his memory, I shall silently leave this introductory page . . .

¹ Photograph in the public domain.

Relativistic Lagrangian

As has been explained in the previous chapter, Lagrangian mechanics is a useful tool for gauge theory to find out the symmetry groups involving certain quantum fields which quantise the known particles that mediate the inter particle fundamental interactions. Therefore, we focus on the relativistic Lagrangian to understand particle physics in the standard model (SM). The Lagrangian is usually described as the difference between the kinetic energy and the potential energy of a particle.

$$L = K - V \quad (6.1)$$

where K and V respectively are the kinetic and potential energies of the particle. However, from the relativistic point of view, this is not right and we have to consider it in terms of momentum given as

$$\mathbf{p} = \frac{\partial L}{\partial \mathbf{v}} \quad (6.2)$$

Integration of this equation gives the proper relativistic Lagrangian for a particle with a rest mass of m_0 under the effect of interaction potential $V(\mathbf{r}, \mathbf{v}, t)$,

$$L = -\frac{m_0 c^2}{\gamma} - V(\mathbf{r}, \mathbf{v}, t) \quad (6.3)$$

which is right for all spacetime points and velocities. Where γ is the relativistic Lorentz factor given in Chapter 2. In fact the format of the equation is right for all relativistic systems. For example, the Lagrangian of the 1D relativistic Harmonic oscillator would be

$$L = -\frac{m_0 c^2}{\gamma} - \frac{1}{2} k x^2 \quad (6.4)$$

where k is the spring constant of the oscillator.

The relativistic Lagrangian equation can be generalised to a particle system as the sum of the free particle terms minus their total interaction potential:

$$L = -c^2 \sum \frac{m_{0i}}{\gamma_i} - V(\mathbf{r}_i, \mathbf{v}_i, t) \quad (6.5)$$

It has been shown by many powerful and successful theories that the interaction potential has a so-called Mexican hat shape,² as shown in figure 6.1.

² The distribution function of a particle is usually in the Gaussian form. The Laplacian (second derivative) of a Gaussian, according to the forms of Schrödinger or Klein–Gordon equations, is in the form of a Mexican hat.

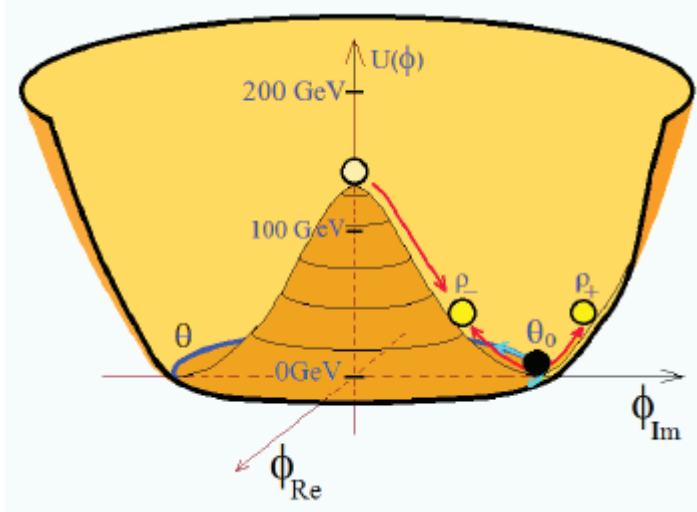

Figure 6.1.³ The Mexican hat model of symmetry breaking. Around $125 \text{ GeV}/c^2$ corresponds to the mass of the Higgs particle that appears in this process.

The particle at the central point has a perfect symmetry but is unstable, “spontaneously” relaxing into stable energies at the bottom, breaking the symmetry and the process from the central to the bottom state, which is called *spontaneous symmetry breaking*. These are the so-called Lagrangian invariant processes and, in order to provide the invariance, a scalar field equivalent to the energy difference between the two energy levels has to be introduced, consolidating the conservation of energy. Quantum mechanical implications show that this scalar field quantises a scalar massive boson, which has to have Einstein’s equivalent mass energy of

$$E_M = Mc^2 = |V_B - V_A| - [\text{Binding energies}] \quad (6.6)$$

where V_A and V_B are the interaction potentials at central and bottom levels, respectively. The difference turns out to be “mass term” in the standard model.

Although the whole story is much too complicated and takes time to explain and understand, the brief predictions given in the paragraph above introduces an easy understanding of the electroweak interaction, for instance, probably mentioned several times earlier. Existence of the heavy scalar Higgs field and consequently the Higgs bosons introduced in

³ After J. Schaf, *Journal of Modern Physics* 10 (2019): 256–80.

electroweak interaction can be explained with a similar analysis of spontaneous symmetry breaking, which also explains why the W–Z interaction gauge bosons have masses.

The only massive scalar boson that is theoretically predicted and experimentally proven is the Higgs boson which has been shown to have an equivalent mass energy of $E_M = 125,09 \text{ GeV}$. The particle is highly unstable with an average lifetime in the order of a septillionth of a second, decaying immediately probably into a new generation vector or tensor bosons. The field of this boson is called the Higgs field, interaction of which with other particle fields relieves whether or not a certain particle gains *mass*, or more terminologically is *given mass* by this field. A special term in Lagrangian interaction is called a “mass term” as an indicator. Although what happens after the decay of the Higgs bosons is unknown, a predicted diagram was given in figures 4.5 and 4.6 of Chapter 4.

Heisenberg’s uncertainty principle in the standard model

In the SM of particle physics, it is predicted that, within the duration of any kind of interaction, the gauge or interaction bosons (photons, W–Z bosons, and g) are produced due to the well-known fact of Heisenberg’s uncertainty principle (HUP),

$$\Delta x \Delta p \sim \hbar \quad (6.7)$$

or, alternatively,

$$\Delta E \Delta t \sim \hbar \quad (6.8)$$

corresponding to the emissions of a “virtual” particle or energy given by

$$\Delta m = \frac{\Delta E}{c^2} \sim \frac{\hbar}{c^2 \Delta t} \quad (6.9)$$

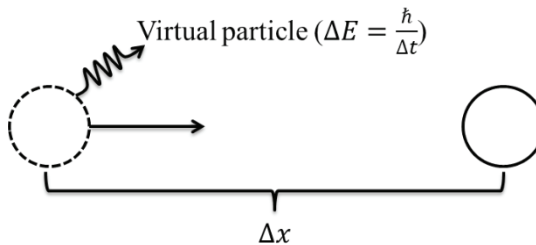

Figure 6.2. A simplified illustration of a particle releasing a virtual particle due to having Δx uncertainty.

This means that a particle with a mass of Δm can exist if its duration is less than Δt . In other words, the loss of a particle, due to the Δx and Δt

uncertainties, results in an emission of a particle having a mass of Δm or the energy of ΔE . This is literally an unusual interpretation of the HUP expressed as “something may appear from nothing if something returns to nothing within very short Δt amount of time defined by Heisenberg’s uncertainty relation.” As shown in figure 6.2, if a particle with a mass of m fluctuates within a Δx uncertainty, then there ought to be an emission of energy or a particle corresponding to the equivalent mass energy of a certain particle. Although it is mostly considered as the micro violations of energy conservation, Feynman’s energy-time diagrams, as in figure 4.4, involving unstable particle–antiparticle annihilations called *virtual annihilation*, can demonstrate all the production mechanisms of the gauge fields.

These force-carrying particles are known as *virtual particles* since they are produced by many virtual-annihilation phenomena occurring around an actual particle, per the duration defined by Δt and due to the HUP. The more mass these virtual particles have, the shorter the time they can exist, according to equation (6.9). Because the photons and the gravitons are massless, they live forever, and the electromagnetic and gravitational interactions can reach infinite distances with the speed of light, while the other two short distance interactions involving the heavy W – Z bosons and the gluons (g) occur only within the nuclei. Although g are considered to be massless and may have the possibility of reaching infinite distances, they cannot exhibit a long-range effect due to the g – g coupling, confining the particles within the nuclei.⁴

Production mechanisms of the force-mediating particles are shown in the Feynman diagrams in figure 4.5 explained in the “Elementary particles” section of Chapter 4. All the experimentally observed mediating bosons were expected to be massless. However, the mass of the W – Z bosons of the weak interaction is explained with Higgs’s symmetry breaking mechanism, which produces the Higgs field as a massive Higgs boson. As mentioned earlier, the bosons are classified in the three categories as the scalar, vector, and tensor bosons. These respectively refer to the scalar mass, as in the case of the Higgs boson, the vector bosons with four types, as in the case of the massive $W^{+/-}$ - Z and massless γ bosons; the hypothetical tensor boson G is similar to the spacetime topology given in general relativity.

The virtual particles existed due to the HUP; sequentially emitted virtual gauge bosons are also considered if they consolidate dark energy, the nature of which is unknown yet. However, the calculations work out to be too much of the virtual energy in order to compensate for the dark energy.

⁴ L. I. Ametller, E. Gava, N. Paver, and D. Treleani, “Role of the QCD-Induced Gluon–Gluon Coupling to Gauge–Boson Pairs in the Multi TeV Region,” *Phys. Rev. D*. 32 (1985): 1699.

Electrons in the standard model

As is said in Anatolia, “It is important to see the vine by looking at the grape and to see something by looking at nothing.” Likewise, in the standard model, all the elementary particles are thought to be massless to start with but they might get mass by a certain transformation. There are certain interaction terms for possible interaction types in the relativistic Lagrangian quantum mechanics. The few of them give “mass terms” that appear after a certain type of process, called *spontaneous symmetry breaking*. While this will be explained later in this chapter, the electron is one of those types of particles that accompany a kind of field that has mass term in Lagrangian interaction. The certain types of fields accompanied with certain particles preserving the *gauge symmetry* turn out to be massless as in the case of photons, gluons, and hypothetical gravitons.

Strangely, the reason why an electron has a mass is its electromagnetic and fermionic nature, that is, its electrical charge. In other words, the mass charge of an electron is due to its electrical charge. The standard model of an electron is shown in figure 6.3. As can be seen in this figure, the electron is not as lonely as we might think from the classical point of view. It is surrounded by many virtual particle–antiparticle pairs due to the HUP that annihilates within Δt amount of time defined by the HUP, propagating interaction bosons—the photons in this case. Propagation of these virtual photons will be distributed spherically, having the acting electron in the centre. The strength (gauge) of the force (the electromagnetic force in this case) would be proportional with the flux of the virtual photons dissipated from the off-shell of the electron.

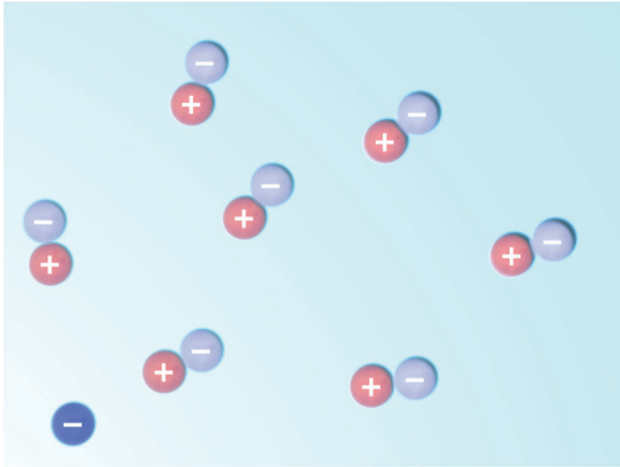

Figure 6.3. Illustration of a quantum mechanical model of electron in the standard model.⁵

According to the HUP, the electron surrounded by the virtual particles (electron–positron pairs) constitutes the electron field. The interaction of this field with the Higgs field produces a mass term, that is, the electron mass. Eventually, the annihilation of the electron–positron pairs, within the duration of

$$\Delta t \approx \frac{\hbar}{\Delta E} \quad (6.10),$$

produces another quantum field of virtual photons that transmits electromagnetism, structuring the gauge bosons of this particular interaction. ΔE in equation (6.10) is the equivalent mass energy of an electron, which is 0.511 MeV. The Feynman diagram related to these phenomena is given in figure 6.4.

⁵ This file is licensed under Creative Commons. Permission is granted under the terms of the GNU Free Documentation License.

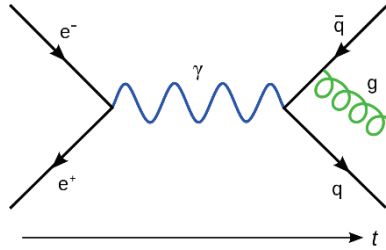

Figure 6.4. The Feynman diagram illustrating the virtual photon emission according to the SM. (Updated by Joel Holdsworth.)⁶

The mass term of electrons is also a consequence of the Pauli principle, since the electron with spin up turns out to have a different transformation than the electron with spin down in the field interaction, resulting in a broken symmetry, violating the gauge symmetry. If there was no Pauli principle on the agenda, electrons would have spins randomly oriented and, therefore, transformation terms would cancel each other, preserving the gauge symmetry, leaving them massless. This is to say that if electrons were somehow bosons, they would not have coupled with the Higgs field and they would probably have been left massless.

On the other hand, superconductivity can be explained from this point of view as follows: An electron–electron coupling occurs under a critical temperature, in a way that electronic field transformations do not break the symmetry, because the electron pairs with zero spins in the material act as if they were a massless boson like quasi-particles (the composite boson called the *copper pair*), resulting in infinite (super) mobility and therefore, superconductivity, due to their *zero-effective-mass*. As the temperature is increased, as a result of the long-range Coulomb interactions, the massless mode is broken to a massive mode, transiting the condensed matter into a normal conducting phase with resistivity. The details of this phenomenon are given in the next chapter.

Vacuum polarisation effect

Although we said that the electron field produces the virtual electron–positron pairs in space (vacuum) as in figure 6.3, its consequences are rather real, called *vacuum polarisation* due to the positive and negative virtual particle–antiparticle pairs around an elementary particle such as an electron

⁶ Permission is granted to copy, distribute, and/or modify this document under the terms of the GNU Free Documentation License.

in free space. In physics, there is no absolute zero or infinity. Even in an absolute vacuum, there would be a background electron field, which renders a non-zero vacuum dielectric constant due to the “distributed capacitance of the vacuum” (permittivity of free space, ϵ_0).

According to quantum field theory, the only measurable vacuum polarisation effect you can get is the virtual particles that progress as photons, that is, the electromagnetic interaction. The reason for this is the fact that the electron is the lightest one in mass, and therefore, the duration of virtual particles is the longest according to the energy-time uncertainty principle. Consequently, vacuum polarisation results in an electric dipole, constituting a universal constant, ϵ_0 .

These vacuum polarisation phenomena provide a crucial importance for the progression of electromagnetism at short range. It has been shown that the classical Coulomb potential, which is anti-proportional with the distance from a point charge, is the reduced consequence of quantum electrodynamics (QED), and classical Maxwell electrodynamics is valid only in distant interactions. For a short distance, shorter than the Compton wavelength, $\lambda_c = h/mc$, there ought to be a fine structure term included in the electromagnetic potential of a point charge in QED,⁷ due to vacuum polarisation provided by the virtual pair production shown in figure 6.3.

The vacuum polarisation and correspondingly the vacuum magnetisation would be proportional with the fine structure and electric permittivity constants because these universal constants are constituted by the polarisation effect of virtual particle–antiparticle pairs mainly due to the electron–positron pairs of the electron field. The vacuum polarisation effect eventually causes a kind of screening or dielectric effect resulting in a drop in the classical potential of a point particle, charged with q , in QED

$$V(r) = \frac{q}{4\pi\epsilon_0 r} \{1 - \alpha f(r)\}, \quad r < \lambda_c \quad (6.11)$$

where the first term is the classical Coulomb potential and the latter is the reduction term, which is the short distance screening effect due to vacuum polarisation. It also explains how electromagnetism becomes short range, allowing the more constrained effects such as weak interaction to be dominant, resulting in electroweak interaction. This is a vital effect in terms of constituting matter in the universe. This is because electroweak interaction is crucial for the formation of nuclei by performing its role as an intermediate between the nucleons to consolidate the strong interaction.

⁷ For further information, see S. Weinberg, *Foundations: The Quantum Theory of Fields* (Cambridge University Press, 2002).

According to equation (6.11), the reduction in potential is proportional to the fine structure constant and can be explained with respect to its physical meaning as follows: The dimensionless fine structure constant α , determining the electromagnetic coupling, is around $1/137$ and is the ratio between the energy needed to break the electrostatic potential of an electron-positron pair with a radius of d and the energy of a photon with a wavelength of $\lambda = d$, that is,

$$\alpha = \frac{e^2/4\pi\epsilon_0 d}{hc/\lambda} = \frac{e^2}{4\pi\epsilon_0 hc} \approx \frac{1}{137} \quad (6.12)$$

Considering the possibility of a virtual photon interaction with a virtual electron–positron pair, the annihilation rate reduces with a proportion of α . Because of this possible reduction in the annihilation rate, the decrease in the number of gauge photons mediating electromagnetism results in a drop in the electrical potential by a term factored by α , in a short distance interaction. The strength of the coupling in equation (6.12) is determined with respect to the photon energy, since the entities under measurement or observation are in principle monitored by light.

Higgs mechanism: mass charge

Every point of spacetime that constitutes the present universe is full of the elementary particle fields that quantise all the fermions and bosons presented in figure 4.2. For example, the photon (γ) is a quantum of the electromagnetic field, the Higgs boson a quantum of the Higgs field, an electron a quantum of the electron field (electron–positron pairs shown in figure 6.3) and so on. These fields configured in spacetime may interact with each other, which is called *field coupling* in particle physics. It is like when the people at a party are influenced by each other’s “aurora” and their behaviour is thus affected.

Although the massless particles don’t interact at all with the Higgs field, the particles that we know of with masses interfere with the Higgs field, that is, their fields should couple with the Higgs Field in a process called *spontaneous symmetry breaking* (see also first section). Before this process, all the elementary particles are considered massless. After this process, it is interpreted that the Higgs Field “gives mass” to a particle, which has taken part in spontaneous symmetry breaking.

I interpret this situation as follows: Some particles are affected by the Higgs aurora (field) and some particles are affected less or not at all, depending on the strength of the coupling (or gauge coupling). For example, the massless photons and gluons are so frivolous that they are not at all influenced and they get no masses. However, the W–Z bosons of the

electroweak interaction have a strong coupling with the Higgs field and they are said to be heavy bosons. All the other massive particles such as electrons, and the other leptons and quarks, get mass depending on the proportion of their coupling with the Higgs field. However, we should underline that the mechanism of a fermion getting mass differs from that of a boson.

Of course, 100% Higgs coupling occurs with itself, giving the highest mass (except for the top quark) to the Higgs boson, which is around $126 \text{ GeV}/c^2$, followed by the Z and W bosons with masses of, respectively, $91.2 \text{ GeV}/c^2$ and $80.4 \text{ GeV}/c^2$. The constant that defines the strength of the coupling between the particle fields is called the *coupling constant* or the *gauge coupling parameter*, g , that is only a dimensionless number.⁸

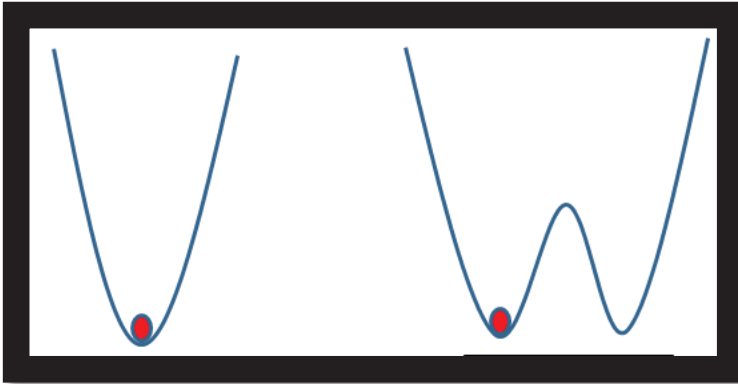

Figure 6.5. A schematic and simple illustration of symmetrical (left) and anti-symmetrical (right) potentials explained by the Mexican hat model on the right, which has a broken symmetry.

A mass giving the spontaneous symmetry breaking process, which I have simplified in my explain above, is the essence of the Higgs mechanism, without which all the elementary particles would have zero-masses. The mechanism, in fact, is explained with the Mexican hat⁹ shape of a potential energy function, $V(\phi)$, accompanying the Higgs field, ϕ , as shown in figure

⁸ For further information, see M. E. Peskin and H. D. Shroeder, *An Introduction to Quantum Field Theory* (Reading, MA: Addison-Wesley, 1995).

⁹ A distribution of this kind can be approximated by Gaussian distribution, which exists in the nature of wave equations if one considers a particle field as a Gaussian around a particle.

6.5. According to one of the fundamental laws of nature—expressed as “all the systems want to be at the possible minimum energy state”—the symmetry of $V(\phi)$ being at the top of the hat is broken by a transition to the circular region at the bottom, losing a certain amount of potential energy (see also figure 6.1). The energy difference between the top and bottom regions of the potential would result in a difference in the Lagrangian or in the Hamiltonian of the interacting fields of the particles, leaving them (Lagrangian or Hamiltonian) with only kinetic terms. The lost potential part (interacting part) due to the symmetry breaking between the top and bottom of the hat returns the counterpart(s) of the Higgs coupling as a *mass*. This is the so-called *Higgs mechanism*, in general.

Now we investigate how an electron field gains mass with the interaction of the Higgs field. As can be seen in the section “Electron in the Standard Model” in figure 6.3., the electron field is the virtual electron–positron pairs that appear around an actual electron according to the HUP. Through the annihilation of these electron–positron pairs, virtual γ -photons are produced that transmit the electromagnetic potential, as shown in the famous Feynman diagram of quantum field theory in figure 6.4. However, let us see what happens before electromagnetism takes place.

Considering the possibility of electron–positron pairs (electron field) coupling the Higgs Field, ϕ , with a strength of g , which is always around in spacetime, we can simply write the Dirac interaction term of the fields as

$$g\Psi^*\Psi\phi \quad (6.13)$$

where Ψ^* and Ψ represent a positron and an electron of the electron field, respectively. Let us say that, by spontaneous symmetry breaking, we lose a scalar amount of potential, V so that we can write a new field

$$H = \phi - V \text{ or } \phi = H + V \quad (6.14)$$

This is to say that

$$g\Psi^*\Psi\phi = g\Psi^*\Psi H + g\Psi^*\Psi V \quad (6.15)$$

The first term on the right is still an interaction term but the second is a kinetic term that has an eigenvalue or expected value, equivalent to a scalar

$$M = gV \quad (6.16)$$

Therefore, we can write the second term as

$$M\Psi^*\Psi \quad (6.17)$$

which is called the “mass term” and illustrates the interaction of an electron and its anti-particle positron. In other words, we have left out the interaction of the second field and are left with the original electron field, having a mass value of M . It means that both particles (electron and positron) now have a mass of M equivalent to (Mc^2) in energy terms, gained with the proportion of a coupling parameter, g , which they didn’t have before spontaneous

symmetry breaking. In addition, this is all consistent with the thermodynamic predictions explained in Chapter 1.

The relativistic mass can probably be explained from the mass term since the coupling parameter, g will be dependent on the particle's velocity, because g apparently increases with the increasing particle velocity.¹⁰ It is thought that the coupling constant, g , will increase by a factor of the Lorentz factor, γ .

This is an extraordinary mechanism that leads us to interpret that mass (matter) is created out of nothing.¹¹ All the other composite particles such as a baryon (proton or neutron) consist of elementary particles that have masses due to this mechanism. Various compositions of the baryons, specifically protons and neutrons together with electrons, constitute atoms and molecules and, therefore, known baryonic matter.

Further predictions

We can think of certain other models that may have spontaneous symmetry breaking. One of them is the harmonic oscillator model, for instance.

Quantum harmonic oscillator model

Although there is a lack of theoretical research and experimental testing is required, a spontaneous symmetry breaking process can be explained with a simple quantum harmonic oscillator model¹² based on the HUP. Any point particle that is listed in the elementary particle table of figure 4.2 can be considered as a quantum oscillator fluctuating around a point within the Δx uncertainty.

¹⁰ How can electromagnetic coupling give relativistic mass? See, for example, P. Marmet, "Fundamental Nature of Relativistic Mass and Magnetic Fields," *International IFNA-ANS Journal Problems of Nonlinear Analysis in Engineering Systems* no. 3 (19), vol. 9 (2003).

¹¹ This is one of the fundamental principles of mystical theology.

¹² See, for example, the recent article by N. Itzhaki and J. McGreevy, "The Large N Harmonic Oscillator as a String Theory," *Phys. Rev. D* 71 (2005).

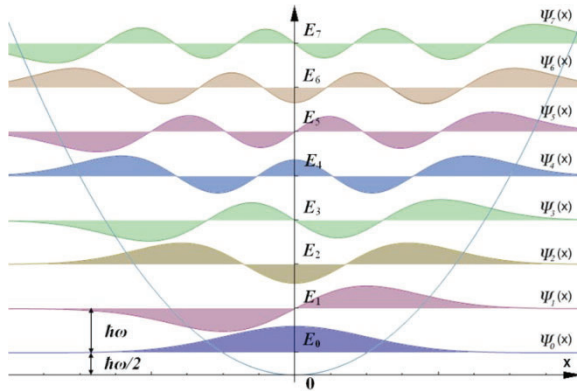

Figure 6.5. An illustration of the energy levels and corresponding wave functions of a simple quantum harmonic oscillator vibrating in the x-direction.¹³

As can be seen in Figure 6.5, the only symmetrical state is the ground state and the particle breaks the symmetry in the higher energy states at which quantisation of a particle shows up with an interval of

$$\Delta E = \hbar\omega \tag{6.18}$$

in order to keep the Lagrangian

$$L = 2K - \langle H \rangle = 2K - E_0 \tag{6.19}$$

“invariant,” at the initial ground state, considering classical $H = K + V$, $L = K - V$, and, therefore, $L + H = 2K$ or $L = 2K - H$. This probably explains the mediating gauge bosons of the SM and probably the mechanism for the emission of the gravitons that are not yet put forward properly. In the SM, an energy quantum of $\hbar\omega$ might be represented as a virtual field of a certain particle, which can be a photon, W–Z bosons, a gluon, or even a graviton, depending on the nature of the particle influencing the environment.

Finally, we will now comment on a unique prediction on the gravitational and electromagnetic fields, which is consistent with the known couplings of gravity and electromagnetism.

Gravity and electromagnetism¹⁴

The two long-range interactions gravity and electromagnetism, having zero-mass and deathless gauge bosons (respectively, gravitons and photons),

¹³ This work has been released to the public domain by its author, Allen McC.

¹⁴ Predictions in this section are entirely speculative, and open to discussion and research, in order to give an idea to readers and scientists.

propagate with the speed of light and can reach infinite distances with reduced intensity as functions of inverse square law.

Let us simply try to understand what is going on in the two kinds of interactions having respectively mass and electrical charges. The unitary mass charge is the Higgs boson (H) discovered¹⁵ recently in 2012 and the unitary electrical charge is the electron (e) discovered in 1881. The first (H) is very unstable decaying in one septillionth of a second and the latter (e) is extremely stable predicted to exist probably as long as the universe remains (4.6×10^{26} years).¹⁶ I believe that the strength of the two interactions relies on this matter: gravity involving an extremely unstable particle (H) and electromagnetism involving an extremely stable particle (electron). Let us have a look at the adventure of an electron and a Higgs boson created first just after “the inception of the universe.” Simultaneous creation is not a required condition.

We shall now look at the influences of the two particles to the environment, predicting that the first (H) propagates gravitation, being the mass charge. We definitely know that the latter (e) mediates the electromagnetism.¹⁷

Using the standard electron model explained earlier in this chapter, an electron mediates the virtual photons having energies equivalent to the electron rest mass according to the concept of the HUP in the SM, which probably corresponds to the discrete energy levels predicted by the harmonic oscillator model. Therefore, the energy of a virtual photon mediating electromagnetism would be

$$\Delta E = \hbar\omega = 0.511 \text{ MeV} \quad (6.20)$$

which is emitted in each time interval given by

$$\Delta t = \frac{\Delta E}{\hbar} = 1.3 \times 10^{-21} \text{ s} \quad (6.21)$$

according to the energy-time version of the HUP. The electron is doing this virtual emission since it was first created up to the present, because it is

¹⁵ The discovery is declared in the following articles: CMS Collaboration, *Physics Letters B* 716 (2012): 30–61; ATLAS Collaboration, *Physics Letters B*, 716 (2012): 1–29.

¹⁶ J. Beringer et al. (Particle Data Group), “Review of Particle Physics,” *Physical Review D* 86, no. 1 (2012); H. O. Back et al., “Search for Electron Decay Mode $e \rightarrow \gamma + \nu$ with Prototype of Borexino Detector,” *Physics Letters B* 525, nos. 1–2 (2002): 29–40.

¹⁷ See also S. Tüzemen, “A Possible Microscopic Model for Gravitational Interaction,” *Physical Science International Journal* 9, no. 1 (2016): 1–6; S. Tüzemen, “Approaching to Gravity?,” *Journal of Physics: Conference Series* 707 (2016): 012003.

persistently stable. It means that the total number of virtual photons emitted from one electron is calculated to be 3.4×10^{38} , during the age of the universe (14 billion years = 4.4×10^{17} s).

However, we cannot assume the same huge amount for a Higgs boson, H, since it is very unstable, living only for a very short duration of 10^{-24} s and having a mass of $126 \text{ GeV}/c^2$, according to the findings of CERN. The same calculation for H is only around a few hundred and this is supposedly the number of the virtual gravitons emitted per one H, in my opinion. This means that the intensity of the virtual gravitons is quite nominal in comparison with virtual photons in the spacetime continuum. The ratio between the two values should release the strength of electromagnetism with respect to gravity, which is in the order of 10^{36} . I should underline that this ratio is quite consistent with the value predicted by the SM in Table 4.1 given in Chapter 4. The model also explains well the inverse square law of both in distant effects, since the virtual photons and gravitons would be distributed around the space randomly, that is, spherically from their sources (respectively e and H) with the speed of photons and gravitons that both disperse with the speed of light.

Let us think that there existed an electron and a Higgs boson in the early universe, respectively mediating electromagnetism and gravitation. The electron is still the source of the virtual gauge bosons of electromagnetism (the photons) due to its deathlessness (lifetime of 4.6×10^{26} years) while the Higgs boson stopped being the source of the virtual gauge bosons of gravity (the hypothetical gravitons) since its death, just 10^{-24} s after its creation. Therefore, the number of virtual photons in the universe is still increasing and will continue to do so as long as the electron remains. However, the number of the virtual gravitons is constant but still mediating gravity, due also to their immortality. This means that the electromagnetism will continue to strengthen in comparison to gravity, as long as the electron is alive, although it is too small (calculated to be in the order of 10^{18} intervals per second) to be felt or measured out of the strength of 10^{36} . In other words gravity, being probably the main actor (if not the only actor) of holding the universe together, slightly weakens as the universe remains and this might be one of the reasons for the miraculous accelerating expansion of the universe, besides dark energy. One important question: Does the weakening of gravity explained here correspond to the weakening of Einstein's cosmological constant (λ)? Or, more clearly, does it correspond to the gradual decrease in quintessence—Q? The answer is probably in the negative, because the decrease in the cosmological constant is due to the decrease in the mass density of the universe while the predicted weakening of gravity is instead relative to electromagnetism.

Overall summary

I will briefly try to summarise some important stages of the universe that are mentioned in this book within the standard model of cosmology and particle physics, which is presently a scientific consensus in the scholastic arena. It is sketchily as follows:

Big Bang

Initiation of the universe and cosmic time t by the insertion of grand total energy; huge heat Q

*Constitution of the first law of thermodynamics (energy conservation),
 $Q = TS$*

Initiation of 3D space (x,y,z)

Planck epoch

Constitution of the second law of thermodynamics, $\Delta S > 0$, and the microscopic universe

Cosmic inflation–inflationary epoch

Initiation of dark energy and accelerating metric expansion

Super-cooling

*Constitution of scale invariant quantum fluctuations and uncertainty,
 $\Delta x \Delta p \geq \hbar$*

Insertion of time as dimension, constituting spacetime

Creation of the elementary particles

Spontaneous symmetry breaking giving mass to certain elementary particles

Initiation of gravity and dark matter

Constitution of lambda–cold dark matter (Λ CDM) model of the universe

First gravitational waves

Large-scale cosmos

Reheating

Creation of hadrons (protons, neutrons, and mesons) due to the strong nuclear interaction

Creation of the small nuclei via nuclear fusions due to the electroweak interaction

Cooling to 3000 K with the ongoing expansion

Creation of small atoms due to electromagnetic interaction

Photon decoupling resulting in the remnant CMBR

Further cooling

Nuclear fusions

Creation of elements

Molecules constituted by interatomic binding

Baryonic matter

Initiation of life

CHAPTER SEVEN

SOME EXTREME STATES

“God not only plays dice,
He also sometimes throws the dice
where they cannot be seen.”
—Stephen Hawking

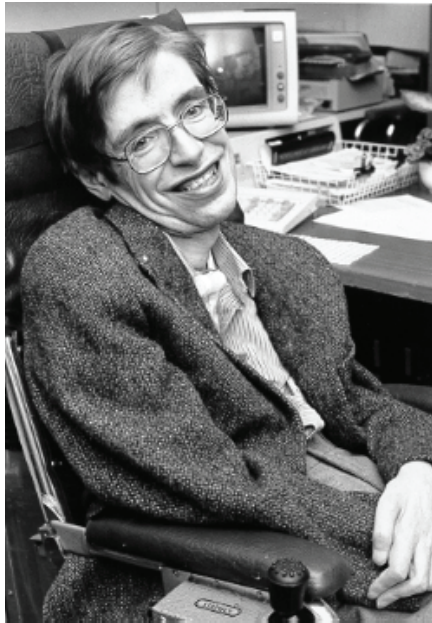

Photograph of Stephen Hawking, the famous theoretical physicist and cosmologist.¹

In this chapter, we will not exactly focus on the things where God has thrown the dice out of sight, as Stephen Hawking mentions; instead, we will focus on extreme situations that may also be related to them. Each topic may

¹ Courtesy of NASA released into the public domain. NASA copyright policy states that “NASA material is not protected by copyright unless noted.”

well be considered as subjects of separate books. However, I would feel this book was incomplete if we did not briefly mention the following important phenomena in the universe. We will look at three important but in a way strange behaviours of the gaseous, liquid, and solid states of nature. Plasma, for instance, is a state prior to the gaseous material but it is not considered as the gas phase. It can transit to gas, and then liquid and eventually solid phases. What would be the formation after the solid state? The answer is probably a black hole. This is to say that one of the early formations of the universe, in the normal baryonic matter sense, is plasma and the final is the heavy solid form, the black hole. It is, in a way, a condensed form of plasma, since it consists of neutrons in a very tightly packed form. However, could the mini and artificial conditions of a black hole state be produced in a laboratory? I haven't heard of an example, but the answer is, although very difficult, why not, if we can reach ultra-high and -low temperature suddenly. This may have been possible by transiting directly from the extreme state of plasma, in which all the electrons are stripped, to the solid state. I am not an authority and don't feel in a position to say, but I somehow intend to call, at the least, the early stage of a black hole the fifth state of matter—a post-solid form—in the sense that its phase and binding, and, therefore, physical properties, differ from the other states of known materials. It can be studied as the theorised phases of matter as in the case of the *quark matters* of particle physics.

About *dark matter*, which probably exists somewhere that God's dice has fallen, we do not know what happens; all we know is the dominant part of matter in the universe and that it doesn't get affected by electromagnetic energy, while probably it is affected by *dark energy*. For sure, we know that dark matter is not affected by electromagnetic radiation because, if we could in some way get the electromagnetic interaction, we would have detected the dark matter, and then we would no longer call it *dark matter*. It is expected that electromagnetic radiation would be affected by the dark matter in the sense of general relativity. In other words, if it curves spacetime, then light would be subject to a sort of gravitational lensing caused by the dark matter. Studies on the dark matter focus on this way but none of the results, to the best of my knowledge, have been reported yet.

In this chapter, we will try to explain the extreme situations in the three different states of matter. Basically all materials are subject to a phase transition, if the appropriate conditions such as temperature and pressure are provided. The earliest stage of matter is plasma at extremely high temperatures. As plasma gradually cools down, it can be upgraded to gas, liquid, and solid states, respectively. However, what happens in the sudden cooling from plasma. This is what happens when stars die out, collapsing

into cool black holes or so-called collapsars. We will also mention the properties of water and the superconductivity of matter, which I think are the fundamental but extreme examples in the liquid and solid phases, that is, in condensed matter states.

Plasma

Plasma—a very early form of matter in the universe, is recognised to be a class of the state well after the gas, liquid, and solid forms. Famous chemist Irvin Langmuir in the 1920s first described it as another phase since its physical properties differ from the known three states of matter. Plasma is essentially ionised gas, formed due to high temperature or electromagnetic effects, exhibiting physical properties that need to be interpreted from its unique behaviours.



Lightning is a good example of plasma in the atmosphere that we can observe in daily life, having high discharge currents, voltages, and temperatures, respectively, in the orders of kilo amperes, gigavolts, and tens of thousands of kelvins in the regions of the air. Light emission covering the whole range of electromagnetic waves is possible.²

² A Dutch photograph distributed under a Creative Commons (CC) license, subject to free licensing.

High concentrations of a gaseous substance become highly conductive so that its long-range electromagnetic field defines the physical properties of the material. These properties need to be handled quite differently than that of other materials in more common states (gas, liquid, and solid). For example, although plasma is considered to contain equal amounts of positive (ionised atoms) and negative charges (electrons), its properties differ from metal in the sense that the free particles are not free in terms of having zero force. Generation of the electromagnetic forces due to the movement of each entity in plasma governs the degrees of freedom. On the other hand, the ordinary gas kinetics cannot be applied to plasma. The classical Maxwell–Boltzmann velocity distribution is not valid for the positive and negative components of plasma. Plasma oscillations of electrons are normally very high in comparison to the usual oscillations of electrons in an ordinary gas since the electronic oscillations in the first are due to the interaction with the positively charged ions while the oscillations in the latter are due to the interaction with the neutral gas atoms. Therefore, the electron oscillation frequency is an important measure to decide as to whether you have an ordinary gas or plasma.

The degree of ionisation in plasma is given by a factor α , which is the ratio between the concentration of ionised gas atoms and total concentration

$$\alpha = \frac{N_i}{N_i + N_n} \quad (7.1)$$

where N_i is the ionised and N_n the neutral concentrations of atoms, respectively. The electron oscillation frequency is highly dependent on the degree of ionisation, describing the gaseous media to be fully or partially ionised. In that sense, a gas in a closed chamber can be converted from gas to plasma by applying an electric field (voltage) as in the case of plasma televisions or fluorescent gas lamps.

Depending on whether the electronic, ionic, and neutral components of a plasma are in thermal equilibrium, it can be respectively classified as *thermal* or *cold*. When the average electronic temperature is extremely high while the ions and neutral atoms are cold, plasma is said to be *cold plasma*. On the other hand, hot plasma, which has ionic and electronic constituents in thermal equilibrium, is *thermal plasma* as in the case of plasma in a star. In the cold plasma that we can obtain from fluorescent Hg-vapour gas lamps, the electrons can be highly energetic while the Hg-ions are cold so that you can even touch the lamp when it is operating. Cold plasma is not necessarily cold in temperature; when for example the ionic temperature is high but the electronic one is low, it is still called cold plasma.

Due to the equal numbers of positive and negative charges over large volumes of plasma, there exists a sort of screening effect called quasi-

neutrality causing very small or zero plasma potentials when measured between the two electrodes, as a consequence of zero-gradient net charges. However, if we can get high gradients of charges in a certain direction of space, it is possible to have high electric fields and consequently potentials, as in the case of beams. Therefore, electron or ion beams would be considered as plasma, having high plasma voltages due to their unipolar behaviours.

Magnetisation of plasma is distinguished by the positive or negative components of plasma being able to perform at least one cycle around a magnetic field before any collisions. In this sense, the magnetisation of plasma is possible in terms of electrons due to the charge-mass ratio. Such a cyclotron has an analogy with the *cyclotron resonance effect* in semiconductors, which has been observed in the “microwave” frequency range at super-cooled temperatures for the determination of the effective mass tensors of free electrons and holes.

Although the unknown form of matter, so-called dark matter, is considered to dominate the matter content of the universe, plasma is the most found form of known baryonic matter in the universe since all the stars fully consist of plasma along with the fact that some planets and even black holes contain plasma, to a certain extent, around their spherical layers. Earth’s ionosphere ranging from 70 to 900 km above the ground is also considered to be plasma due to the ionisation caused by the sun’s radiation. The interiors of the sun and stars are fully ionised plasma due to their ultra-high temperature environment provided by nuclear fusion processes. On the other hand, the solar winds as well as intergalactic, interstellar, and interplanetary space contain plasma.

Plasma can be produced in our natural and artificial environment in daily life. For example, lightning in the air is due to the plasma effect of air, becoming highly conductive due to its ionic gaseous nature. Some artificially designed electronic devices such as plasma screens are based on the response of plasma to the electromagnetic signals. Plasmas are also used in high technology, state-of-the-art semiconductor processing, and device fabrication such as in plasma etching, reactive sputtering, plasma enhanced chemical vapour deposition, molecular beam epitaxy (MBE) techniques, and so on, among others in spacecraft technology.

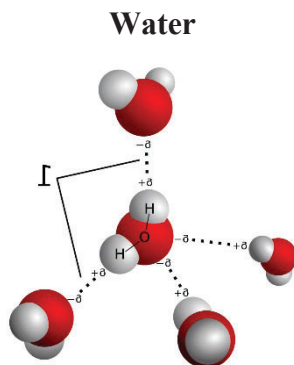

Figure 7.1. An illustration of water molecules having the two H^+ positive ions bonding with the neighbouring negative O^{2-} ion called hydrogen bonding. This kind of bonding between the water molecules gives the extraordinary properties of all phases (vapour, water, and ice). (Licenced under the CC)

Water is simply one of the most crucial and extraordinary materials in terms of the life codes of the universe, due to its unique physical properties. As probably everyone knows, water consists of an oxygen atom covalently bound to two hydrogen atoms, constituting the chemical formula of H_2O . That is, water is the “ash” of hydrogen gas reduced by burning with oxygen. Renewable *hydrogen energy* is a sort of experimental treatment of this process.

On the other hand, water condenses to ice at $0^{\circ}C$ in normal atmospheric conditions, having bonded the positive hydrogen to the negative oxygen of the H_2O molecules together, which is so-called hydrogen binding, as shown in figure 7.1. The hydrogen bonds give the most extraordinary behaviour of water, reducing its density by 9%, rather than increasing, in the process of transiting from the liquid to the solid phase. Therefore, it is presumably the only natural material that doesn't shrink by condensing. This is definitely the most important vitality for the sort of life that we know on Earth. If that wasn't the case, we could not have seen the photograph overleaf (even if we were alive for some reason!), since the iceberg would be heavier than water and would be under the ocean. Anyway, we could not have seen it at all, because there would be no life.



Iceberg floating on the sea due to its lower density

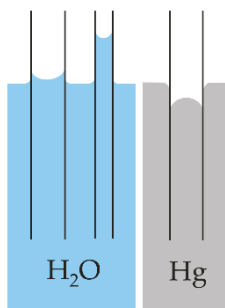

Figure 7.2. An illustration of water's capillary action in contrast to other liquids such as mercury. This property allows plants to be fed by water. (Author: MesserWoland, licenced under the Creative Commons)

The unique electro-polar behaviour makes water a good polar solvent, dissolving the natural biological macromolecules such as DNA and proteins in living organisms that are vital for life. The same polar behaviour gives it a reverse capillarity action in comparison to the other liquids as shown in figure 7.2. Because of the polar behaviour, water or ice can form hydrogen bonds with the other neighbouring molecules, resulting in capillarity upwards against the gravity and that is also crucial for life, because water can move up to plants and trees.

Hydrogen bonds are also crucial for preventing droughts on Earth, because the bonds in the liquid phase provides a high temperature gap of around 100⁰C between melting and boiling points, and yet it is probably the

only compound that remains in solid, liquid, and gas phases in normal atmospheric conditions. This important property reduces the vaporisation of water and sublimation of ice that moderates the climate on Earth.

Another useful thing for life and nutrition (although it is not nutritious) is that the vibrational and rotational modes of a water molecule drop into the microwave energy region. This renders resonant absorption of microwave energy, which allows a microwave oven to warm up moistures in food when heating or cooking our meals.

Superconductivity

Superconductivity is a state of phase transition in the electron scale. In other words, while the macroscopic solid phase remains, microscopically it is a phase transition, influencing the overall macroscopic properties such as electrical conductivity. I will again give the analogy of Matryoshka dolls as phases are interpenetrated with one another like the dolls, and various phases can appear due to different external effects and conditions.

Superconductivity was first discovered by Onnes in 1911 in mercury (Hg) below the liquid helium temperature. The temperature is called the critical temperature below which the conditions for a superconducting phase take place in order to render infinite conductivity or zero resistivity even though the power supply is turned off. It has been shown that superconductivity can recover to normal conductivity above the critical temperature since the magnetic field produced due to Lenz's law gets higher than the critical value of an external magnetic field.

Classically, it can be considered that superconductivity is an idealised form of normal conductivity. In other words, as the conductors cool down, the collisions between the electrons reduce and consequently they can reach a very long *mean free path*, that is, very high conductivities. However, it has been shown that it is not simply like this. It is a phase transition that transforms the free carriers of material from fermions to bosons by pairing the electrons.

Theoretically, Cooper was the first to show that there exist pairs instead of individual electrons pursuing the conduction with boson-like pairs (obeying Bose–Einstein statistics) rather than fermions governed by Fermi–Dirac statistics. Normally electron–electron repulsion occurs with electromagnetic interaction, involving massless photons as the virtual bosons. However, the electron–electron pairs can be produced by the symmetry breaking electron–phonon–electron coupling involving heavy phonons as the gauge bosons in cooled materials, which act as superconductors at temperatures below the “critical” temperature, T_c .

The Cooper pairs always exist even at temperatures higher than T_c , although the concentration is low in comparison to the unpaired electrons. In the paired electron mode, the pairs are boson like with $-2e$ charges and zero spins so that the magnetic field is expelled (known as the Meissner effect) from the material up to a critical magnetic field strength H_c or a critical temperature T_c , above which the electron pairs recover to individual electrons and the material returns to normal conductivity, breaking the pairs.

Again, I shall try to give an example from social life: Let us think of 100 people partying, where 50 people have one opinion and the other half have the opposite opinion, as in the case of free electrons in metals, according to the Pauli exclusion principle. They, therefore, randomly walk around the party and, when they see their opposite, they escape from one another and scatter (this is like normal conduction). After a couple of drinks (phonon assistance in superconductivity), the party warms up (cools down in the case of superconductivity) and, eventually, they become friends (pairs) and they can move freely without “scattering” (this is like superconductivity), until a provocateur (an external field greater than H_c or heating above T_c) appears breaking the “friendship” (pairs).

In terms of the HUP, in the normal conduction of free fermions (electrons, $-e$), they scatter having indefinite velocities (momentum), resulting in $\Delta p \rightarrow \infty$ and consequently $\Delta x \rightarrow 0$. However, the other way around is true in superconductivity of bosons (Cooper pairs, $-2e$) with the uncertainties of $\Delta p \rightarrow 0$ and $\Delta x \rightarrow \infty$. This is consistent with the electromagnetic force reducing the short range. On the other hand, the infinite uncertainty in position refers to the infinite de Broglie wavelength given in Chapter 3, meaning an elevated conduction of the pairs, that is, superconductivity.

Another interpretation, from a different perspective in terms of the quantum fields, is as follows (see also Chapter 6): The phonon assisted electron–electron coupling (the Cooper pairs)³ comes into play below a critical temperature converting the individual electrons (fermions) to the pairs that act like bosons in a superconductor. The interaction (gauge coupling) of individual electrons (fermions) with the mass-giving Higgs field is quite different from the interaction of the Cooper pairs with the same field. The pairs having zero-spins coupling with the Higgs field, in a way don’t end up with a symmetry breaking process, contrarily preserving the gauge symmetry. This situation leaves the pairs in a position acting like massless bosons, resulting in infinite mobility and therefore, superconductivity,

³ These pairs are called *quasi bosons* since the e–e pairs would have zero spins in total.

according to the first principle transport predictions of solid state physics.⁴ One can speculate that this is why there are no such massless particles generated in the Higgs mechanism eventuated in nuclei. This situation is not the case in the Higgs mechanism since the generation is fermions (neutrons), not bosons, in the electroweak interaction, giving mass to the individual species within the interaction. General similarities and differences between the superconductivity and Higgs mechanisms are given in the next section of this chapter and tabulated in table 7.1.

As the temperature is increased, as a result of long-range Coulomb interactions becoming dominant, the massless mode is broken to the massive mode, transiting the condensed matter into a normal conducting state with resistivity.

If the Cooper pairs are left massless within the material, this situation should, in this author's opinion, appear as a slight weight loss of a superconductor when it crosses from a normal to a superconducting state. Provided that there are free electrons in the order of the Avogadro number (6.02×10^{23}) per cubic centimetre, the simple calculation of weight loss would be in the order of micro grams per cubic centimetre, which is measurable. De Aquino⁵ apparently points out the weight loss of superconductors, theoretically in 2002, Tajmar et al.⁶ have experimentally tested this situation, for instance.

However, this mustn't be mixed up with magnetic levitation, which is the effect of the magnetic field of the surface currents of a superconductor acting on a magnet, as shown in the photograph overleaf. This property is especially used in ultra-high-speed railway technology, breaking the friction between the railway and the train.

⁴ The predictions are only an interpretation and lack any theoretical or experimental tests.

⁵ F. De Aquino, "Gravitational Mass at the Superconducting State," Los Alamos Archive, physics/0201058, 2002.

⁶ M. Tajmar et al., "Weight Measurements of High-Temperature Superconductors during Phase Transition in Stationary, Non-Stationary Condition and under ELF Radiation," arxiv.org (2004).



Photo of magnetic levitation, using high temperature superconductor $\text{YBa}_2\text{Cu}_3\text{O}_7$ at the bottom.⁷

Interestingly, superinsulation, which was discovered recently in 2008, is considered to have been achieved with the same mechanism of superconductivity. For example, a candidate for a superinsulator would probably involve pairing the electrons with the holes in semiconductors or insulators at low temperatures, thus to produce quasi-bosons with zero-charges and spins in the material. Super-fluidity is also a sort of effect that becomes due to the phase transition from fermions to bosons.

Superconductivity versus Higgs mechanism

Another mechanism that is inspired from superconductivity is the Higgs mechanism of particle physics explained by spontaneous symmetry breaking in the Mexican-hat potential model given in Chapter 6. In fact, some call the Higgs mechanism the superconductivity of charged particles in a vacuum.

Superconductivity begins with the high density of the Cooper pairs (bosons) in the material also called *Bose–Einstein condensation*. This effect causes the expulsion of the magnetic field from the material, which is named the *Meissner effect*, as illustrated in figure 7.3. This effect is sometimes

⁷ Public domain image by Julien Bobroff and Frederic Bouquet of LPS, Orsay, France.

called a perfect diamagnetism or *super-diamagnetism*⁸ since it means precisely a magnetic susceptibility of -1, defeating any magnetism inside.

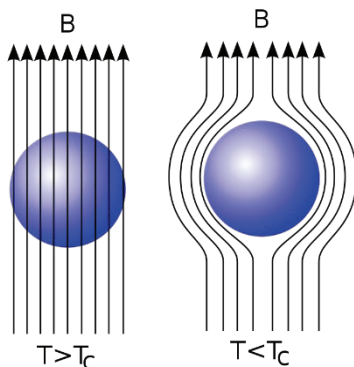

Figure 7.3. A simple illustration of the extraordinary Meissner effect being a magnetic field shield. (Public domain image by Piotr Jaworski)

This effect is formulised by the London brothers as the London equation given by

$$\nabla^2 H = \lambda^{-2} H \quad (7.2)$$

postulating that magnetic field B can penetrate with a penetration depth of λ producing a magnetic field intensity of H within the material, depending on the level of boson condensation, that is, contingent upon the distribution density of the Cooper pairs. Provided that the boson density distribution is Gaussian like, the effect of an external magnetic field, due to the fact that Cooper pair density will be at its maximum at the centre of the material, H distribution will be the reverse of that in the material. Therefore, the London equation means that the Laplacian of a Gaussian is equivalent to a Gaussian just as in the case of the Higgs mechanism, remembering that the Laplacian of a Gaussian would be in the form of the Mexican hat distribution. This situation is simply illustrated in figure 7.4.

⁸ This kind of diamagnetism differs from the one in normal material that results from electronic spins in orbitals of atoms and molecules.

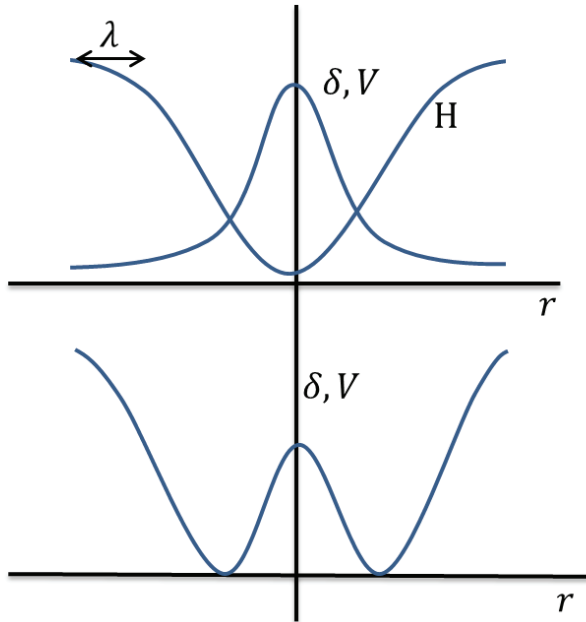

Figure 7.4. Distribution of the Cooper pair concentration (δ), interaction potential (V), and magnetic field intensity (H) (at the top), and the equivalent Mexican hat distribution (at the bottom) for constant λ , according to the London equation.

The equivalence of both distributions means a symmetry breaking process, resulting in a shift in the interaction potential in both the superconductivity and Higgs mechanisms. The interaction potential would have the same distribution with the particle density since it will be absolutely high where the density is high, depending on the absolute square of the wave-function given by the Schrödinger equation of the Bose–Einstein condensate:

$$i\hbar \frac{\partial}{\partial t} \psi = \frac{\hbar^2}{2m} (\nabla - iq\mathbf{A})^2 \psi \quad (7.3)$$

with vector potential \mathbf{A} .

Apart from this important analogy, the generations of the two mechanisms differ from each other as summarised in table 7.1.

Table 7.1. Comparative features of superconductivity and Higgs mechanism.

	Superconductivity	Higgs mechanism
Interacting particles	Electrons	Leptons and quarks
Mediating virtual gauge bosons	Photons (γ) and heavy phonons (Cooper model ⁹)	γ , g , W^\pm and Z bosons (the standard model)
Type of interaction	Electron–phonon–Electron	Electroweak
Generations	Cooper pairs (boson)	Neutrons (fermion)
Critical temperatures (T_c)	Low (<140 K)	Very high (< 10^{12} K)
Magnetisations	Diamagnetic ($H=0$, Meissner Effect—Super-diamagnetism)	Paramagnetic ($H \neq 0$, Nuclear magnetic resonance—NMR)
Outcome	Superconductors	Plasma

Black hole

Early stage of a black hole

The early stage of a black hole is formed by the dying out of a star consisting virtually of only neutrons¹⁰ and electrons, which is probably considered to be cooled plasma. It is definitely a dense material in the sense that its mass-to-volume ratio is too high, still having dimensions containing a size, even if it is too small in comparison to the sizes of stars or even planets. This kind of structure would have quite high gravitation but would still not have enough gravitation to be a black hole which even something with the speed of cosmic limit (light) would not escape from.

However, it has an ability to be a black hole, because as it catches the masses around it, it gets more and more massive, and eventually its own gravitation squeezes itself, collapsing it into a point size (nearly zero size). At this stage, even the neutrons and electrons squash to be as dense as “infinity.”

Black hole

As described by its name, *black*, even light is swallowed by a black hole in the sense of general relativity that predicts extremely sharp bending of spacetime for it, exhibiting infinite flatness in its time direction, due to its infinite gravitation.

We can probably understand this phenomenon better through the following explanations. There is always a possibility of an object being free

⁹ L. N. Cooper, *Phys. Rev.* 104 (1956), 1189.

¹⁰ It is considered that if electrons orbiting an atom crash into the nucleus during the collapse, all the protons combine with electrons, constituting only neutrons.

(to escape) from the gravitational influence of a planet where it used to be before escaping, if it has sufficient velocity, of at least

$$v_e = \sqrt{\frac{GM}{r}} \quad (7.4)$$

which is called the minimum escape velocity or just the escape velocity, where G is the universal gravitation constant, M , and r the mass and the radius of a particular planet. In this sense, the escape velocity on Earth is around 11.2 km/s. As you reduce r by keeping M constant you can increase v_e . For $v_e = c$, the radius, r , is equal to 9 mm for a planet in the Earth's mass. This means Earth can be a black hole if it squeezes to a size of at most 18 mm diameter, keeping its mass conserved. For a black hole in the Earth's mass, the 18-mm diameter sphere, from where even light cannot survive, is called the *event horizon* and the central point is a "singularity."¹¹ The radius of an event horizon is called the *Schwarzschild radius*— R_s in a black hole. Singularity is the centre of an event horizon where all the mass of the black hole is concentrated at a "single" point. A schematic diagram illustrating a black hole is given in figure 7.5. Outside the event horizon, some can escape depending on their velocity. Lower the velocity further of the event horizon in order to disentangle from it.

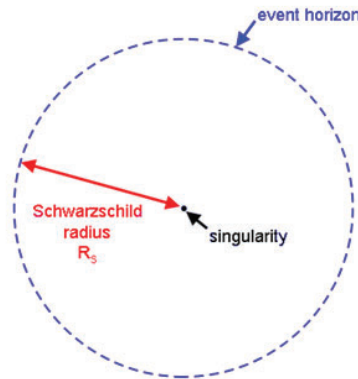

Figure 7.5. A schematic illustration of the main parts of a black hole: the event horizon and singularity. The Schwarzschild radius is calculated according to the escape velocity of a particle with the speed of cosmic limit: the speed of light, c . (Released by NASA)

¹¹ This is where spacetime curves infinitely so that time stops, which can be considered an equivalent to reaching the speed of light in relativistic terms.

A black hole is considered to be a perfect “black body” because it absorbs everything that comes toward it. In this context, it was theoretically predicted by Hawking in 1974 that there ought to be black body radiation called *Hawking radiation* from the surface of the event horizon corresponding to the thermal radiation at the temperature of a black hole. However, it is less than a billionth of a kelvin, the lower limit of that depending on the mass of a black hole, M_{\odot} , and thus the observation of the black body radiation at these ultra-low temperatures is virtually impossible. According to Einstein’s equivalent mass energy, it is predicted that the Hawking radiation reduces the mass of a black hole over a long period of time. Therefore, it is sometimes called *black hole evaporation*, resulting in the constitution of theories such as *quantum gravity*.



Image of a black hole observed for the first time ever.¹² (Courtesy of EHT)

These theories motivated scientists to establish various real and thought experiments, constituting mini black holes that orbit matter rather than swallow the matter—a sort of “gravitational equivalent of an atom.” It is predicted by the quantum gravity theory that they should emit X-rays when they evaporate. However, no experimentally confirmed data have been

¹² There is actually no direct image of a black hole other than this indirect but magnificent image of some gravitational lensing effects recently launched on 11 April 2019 by the researchers of the Event Horizon Telescope (EHT) project. To create such images of a black hole, the research team interconnected radio telescopes located around the world and analysed the 5 petabytes of data accumulated from the EHT network.

declared yet either due to obtaining an insufficient amount of mini black holes or because no evaporation occurred.

Returning to astronomic black holes, they are classified as *staller mass black holes* being up to 20 times more massive than the sun. They are usually formed by collapsed stars running out of fuel. They are situated often where stars are, throughout the galaxy, proving the idea of formation after the death of a star. They can also exist as binaries, indicating that they can be formed from twin stars, as well. On the other hand, those having masses that are millions to billions times heavier than the sun are called *supermassive black holes* and considered to be situated in the middle of galaxies. It is a scientific consensus between astronomers accepting that virtually all galaxies must have a supermassive black hole in their centre so that everything rotates around it. The mass of the supermassive black hole is in proportion to the mass of the galaxy, indicating the probable fact that the formation of galaxies started with the formation of a supermassive black hole.

Direct observations of black holes are virtually impossible, since all the electromagnetic radiation is “blackened” by them and the thermal radiation (Hawking radiation) is under the detection limits of presently available systems. The existence of them is known without a doubt, from their indirect effects, proposing that there ought to be something very tiny in size but heavy in mass (dense), in order to explain certain physical observations happening in the galaxies. Imagine that you come home and see that everything including the burglar alarm has gone off, at which point you are sure that you have been burgled by somebody, but that you cannot see anything or who the thief is from the cameras because he or she was wearing something that made him/her unseen, “black.”

Thermodynamic predictions for black holes

According to the third law of thermodynamics, it is indicated that there ought to be a constant entropy at temperatures as low as the temperature of a black hole, virtually absolute zero. It has been shown by Hawking that the surface area (A) of the event horizon of a black hole should be constant no matter how much material it merges. On the other hand, Bekenstein proposed that the entropy of a black hole is proportional to the surface area of it as follows,

$$S \propto A \quad (7.5)$$

preserving the third law of thermodynamics. Therefore, S is called Bekenstein–Hawking entropy.

One important matter at this point is that, according to Einstein’s equivalent mass energy, black holes lose mass due to Hawking radiation,

and consequently should shrink, reducing the surface area and therefore, the entropy with respect to equation (7.5). This situation seems to conflict with the second law of thermodynamics, which proposes that the entropy of something that is isolated or is being interfered with by other systems never reduces the entropy, but increases it. In other words, the theories invoked for the explanation of the third law seem to be violating the second law of thermodynamics. However, this matter is still open to discussion.

The following suggestion with an analogy to the Gaussian law may be a solution for this problem as follows: The total heat dissipated from a black hole due to Hawking radiation should be proportional to surface integration of a field, H , representing the radiation, and this should be proportional to the mass of the black hole, M_{\odot} , within the surface of the event horizon, A . In mathematical terms

$$\int T dS \propto \int H dA \propto M_{\odot} \quad (7.6)$$

The integration of this

$$\Delta S \propto \frac{4\pi R_s^2}{T} H \propto M_{\odot} \quad (7.7)$$

which is definitely a positive change in the entropy, S . According to equation (7.7), the increase in the entropy is proportional to the surface area of the event horizon, as proposed by Bekenstein–Hawking entropy, as well as to the mass of the black hole, even though M_{\odot} reduces over time. This means change in S always increases, although it is too slow, but the increase in S , that is ΔS reduces by the reduction of M_{\odot} as a function of time, due to Hawking radiation.

Finally: we started with the Big Bang having zero-mass and ended up with highly dense massive black holes; likewise, the universe did, trying to explain what is going on between the two extreme events. The universe is created in the seven steps as given in Chapter 1, which is just a coincidence with the number of chapters in this book. I hope readers can now imagine to some extent how the universe is coded with respect to the quantum and cosmic implications of modern physics. Of course, what we can observe and understand are the elements that are decoded by human beings or by nature itself. I am sure there exist many more issues that are not resolved and still stand as secrets. . . . they are waiting for you to decode them!

SUBJECT INDEX

- age of the universe, 52
- amber, 81
- angular XE "angular momentum"
momentum, 70
- angular momentum, 36
- angular momentum, 70
- annihilation, 18, 88, 89, 108, 114,
116, 119, 121
- anti-matter, 83, 85, 101
- anti-particles, 85
- anti-quarks, 5, 8
- ATLAS, 83, 124
- Avogadro number, 16, 136
- baryonic hadrons, 92
- baryonic material, 92
- baryonic matter, 3, 95, 97, 122, 128,
131
- Bekenstein-Hawking entropy, 144
- Bell's ground-breaking theorem, 73
- bending of light, 42, 44
- Beta-decay, 94
- Big Bang, 2, 4, 5, 6, 8, 9, 12, 13, 15,
18, 21, 48, 75, 109, 126, 144
- Big Bang cosmology, 13
- Big Crunch, 21
- Big Rip, 21
- black body, 13, 20, 54, 55, 56, 58,
142
- black body radiation, 20, 55, 58,
142
- black hole, 2, 20, 80, 128, 140, 141,
142, 143, 144
- black light bulb, 65
- blackbody radiation, 55
- Block Functions, 60
- blue shift, 35
- Bohr radius, 16
- Bohr's atomic model, 60
- boiling point, 133
- Boltzmann constant, 16, 55
- Bose-Einstein condensation, 137
- Bose-Einstein distribution, 57
- Bose-Einstein statistics, 85, 134
- bosons, 7, 57, 82, 83, 85, 86, 87, 88,
89, 91, 92, 95, 96, 97, 101, 104,
105, 106, 107, 108, 113, 114,
115, 116, 117, 119, 120, 123,
125, 134, 135, 137, 140
- breakdown voltage, 68
- capillary action, 133
- CERN, 29, 83, 88, 101, 125
- Chronology, 18
- chronology of the eras, 18
- classical pendulum, 70
- classical physics, 27, 54, 58, 63, 64,
74
- closed universe, 19
- CMS collaboration, 83, 124
- cold plasma, 130
- cold" plasma, 130
- collapsars, 129
- color charge, 87
- colour charge, 93
- colour states, 93
- colour temperature, 13, 57
- Colours, 96, 98
- commutation principle, 69
- Compton Effect, 59
- Compton scattering, 59
- Compton shift, 59
- Compton wavelength, 59, 118
- conduction band, 72
- confined particle, 67
- Cooper pairs, 135, 136, 137, 138

- Copenhagen interpretation, 75
 Copenhagen Interpretation, 62, 73
 Copper pair, 117
 Correspondence Principle, 58
 cosmic background explorer, 13, 14
 Cosmic black body radiation, 55
 cosmic calendar, 18
 cosmic inflation, 5, 6, 8, 54
 Cosmic Inflation, 126
 cosmic limit, 140, 141
 Cosmic Microwave Background
 Radiation, 5, 12, 13, 14
 cosmic noise, 12
 cosmological constant, 8, 17, 46, 47,
 125
 Coulomb potential, 118
 Coulomb's electrostatic field, 90
 coupling constant, 99, 101, 120, 122
 coupling constants, 98, 99
 coupling parameter, 120, 121, 122
 Couplings, 97
 Creation, 2, 62, 126
 critical realism, 76
 critical realist, 76
 critical temperature, 117, 134, 135
 curvature scaler, 47
 cyclotron resonance, 131
 D'Alembertian operator, 103
 d'Broglie wavelength, 37, 135
 Dark Ages, 19
 dark energy, 4, 9, 16, 17, 18, 21, 46,
 47, 79, 114, 125, 126, 128
 Dark Energy, 17, 18
 dark mass, 17
 dark matter, 4, 5, 9, 16, 17, 19, 46,
 126, 128, 131
 Dark-Energy Dominated Era, 18
 Davy Jones' Locker, 20
 de Broglie wave, 65
 de Broglie wavelength, 59, 61, 64,
 66, 68
 de Broglie-Bohm theory, 73
 decay processes, 86
 degenerate energy levels, 67
 degrees of freedom, 66, 130
 DESY, 84
 detailed balance, 72
 determinism, 2, 54, 60, 73, 75, 105
 diamagnetism, 138, 140
 Dirac interaction, 121
 discrete energy levels, 67, 72, 124
 doomsday, 20
 Doppler effect, 12, 34
 Doppler shift, 12
 early universe, 15, 19
 Earth, 3, 19, 25, 28, 38, 39, 129,
 131, 132, 133
 effective mass, 131
 eigenfunction, 60
 eigenvalues, 60
 Einstein tensor, 46, 47
 Einstein's equivalent mass energy,
 8, 112, 142
 Einstein's Field equations, 47
 Einstein's Photoelectric Effect, 59
 Einstein's relativity theory, 23, 74
 Einstein's thought experiments, 27
 Einstein's train, 26
 Einstein-Minkovski, 104
 Einstein-Podolsky-Rosen (EPR)
 paradox, 73
 Einstein's thought experiment, 28,
 39
 electric constant, 15
 electric dipole, 118
 electromagnetic field, 88, 101, 116,
 119, 130
 electromagnetic interaction, 80, 82,
 87, 92, 93, 95, 97, 99, 104, 105,
 118, 126, 128, 134
 Electromagnetic interaction, 81
 electromagnetic radiation, 3, 15, 54,
 55, 56, 86, 104, 128, 143
 electromagnetism, 54, 80, 81, 82,
 83, 87, 91, 92, 93, 96, 97, 99,

- 108, 116, 118, 119, 121, 123, 124, 125
- electron, 58, 59, 61, 63, 64, 65, 81, 82, 92, 94, 99, 106, 115, 116, 117, 118, 119, 121, 124, 125, 130, 131, 135
- Electron, 115, 117, 121, 124, 130, 140
- electron-electron coupling, 92, 135
- electron-electron pairs, 134
- electron-phonon-electron coupling, 134
- electrons, 13, 59, 61, 69, 71, 72, 86, 93, 117, 120, 122, 128, 130, 131, 134, 135, 136, 140
- Electroweak force, 82
- electroweak interaction, 5, 82, 92, 106, 107, 112, 118, 120, 126, 136
- electroweak symmetry, 97
- electroweak symmetry breaking, 88
- electroweak theory, 98, 106
- elementary charge, 15
- elementary particles, 8, 85, 88, 92, 95, 106, 108, 119, 122
- Elementary particles, 85
- energy band, 67, 72
- energy conservation, 104, 114, 126
- energy-time, 14, 96, 114, 118, 124
- Entanglement, 61
- entropy, 2, 6, 7, 8, 19, 21, 62, 143, 144
- epistemology, 74, 76
- equivalence principle, 38, 41, 46
- Equivalence principle, 38
- Equivalence Principle, 38, 45
- equivalent mass energy, 36, 96, 113, 114, 116, 143
- escape velocity, 141
- ether, 26
- Euclidean, 45, 46
- Euclidian, 33, 34, 104
- Euclidian Geometry, 33
- event horizon, 141, 142, 143, 144
- Exclusion principle, 61
- Faraday's induction law, 58
- Fermi-Dirac statistics, 58, 85, 134
- fermions, 58, 61, 85, 86, 92, 95, 105, 119, 120, 134, 135, 137
- Feynman diagram, 88, 90, 116, 117, 121
- Feynman diagrams, 86, 87, 114
- fifth state, 128
- fine structure constant, 16, 99, 119
- fine-tuned" universe, 15
- first law of thermodynamics, 7, 126
- first principle of the universe, 7, 54
- flavour, 93, 94, 95, 97
- flavourdynamics, 94
- flavours, 92, 94, 95
- Flavours, 98
- fluctuation theorem, 6
- four dimensional space, 48
- Friedmann Equations, 19
- fundamental constants, 15
- fundamental forces, 7, 14, 17, 21, 79, 82, 87, 97, 98, 106, 107, 108
- fundamental interaction, 80, 94, 97
- Fundamental interaction, 92
- fundamental interactions, 90, 107, 111
- fundamental strong interaction, 92, 93
- galaxies, 2, 3, 4, 9, 10, 11, 16, 19, 143
- galaxy, 143
- Galilean relativity, 23, 24
- Galilean space, 49, 52
- Galileo transformations, 24, 25, 30
- Gamma Functions, 60
- gas, 4, 13, 58, 128, 129, 130, 132, 134
- gauge, 4, 7, 82, 83, 84, 86, 87, 95, 97, 101, 104, 105, 106, 107, 108, 111, 113, 114, 115, 116, 117, 119, 120, 123, 125, 134, 135

- gauge bosons, 86, 95, 106, 125, 134
- Gauge Bosons, 98, 107, 140
- gauge fields, 105, 106, 114
- gauge symmetry, 115, 117, 135
- Gauge Theories, 107
- gauge theory, 4, 101, 105, 106, 111
- Gauge Theory, 83, 103, 105, 107
- Gaussian, 6, 111, 138, 144
- General relativity, 37, 42, 46
- General Relativity, 23, 37, 41, 45, 47, 51, 54, 79, 80, 81, 90, 92, 97, 101, 114
- generation mechanism, 89
- Geometrical relativity, 31
- g-g interactions, 104
- Global Positioning Systems, 46
- global symmetry, 105
- gluon-gluon interaction, 92
- gluons, 5, 8, 84, 91, 92, 93, 94, 95, 98, 106, 108, 114, 115, 119, 123
- Gluons, 84, 92, 98
- God Particle, 83
- Grand Unified Theory, 79, 101, 108
- gravitation, 15, 37, 42, 46, 47, 79, 80, 81, 85, 89, 90, 95, 99, 106, 108, 125, 140, 141
- gravitational acceleration, 9, 81
- gravitational constant, 2, 15, 47, 99
- gravitational field, 39, 40, 41, 43, 47, 80, 89, 90
- gravitational interaction, 89, 99, 106, 114, 124
- gravitational Law of Newton, 47
- gravitational lensing, 17, 45, 128, 142
- Gravitational lensing, 45
- gravitational mass, 38, 39
- gravitational waves, 15, 47, 126
- gravitational-wave astronomy, 15
- graviton, 85, 92, 95, 106
- gravitons, 79, 80, 89, 91, 95, 97, 114, 115, 123, 125
- gravity, 37, 39, 41, 42, 43, 45, 46, 47, 48, 52, 54, 79, 80, 81, 83, 87, 89, 91, 95, 96, 97, 101, 124, 125, 126, 133, 142
- Gravity, 79, 89, 106, 108, 123
- hadrons, 5, 8, 88, 92, 93, 94, 95, 98, 122, 126
- Hamiltonian, 59, 101, 103, 104, 105, 107, 121
- Hamiltonian operator, 59
- harmonic oscillator, 70, 122, 123
- Harmonic oscillator model, 122, 124
- Hawking radiation, 142, 143, 144
- heat, 2, 4, 5, 6, 8, 126, 134, 144
- Heath Death, 20
- heavy phonons, 134
- Heisenberg Uncertainty Principle, 62, 70
- Heisenberg's microscope, 65
- Heisenberg's Uncertainty Principle, 7, 54, 100
- Hermit Polynomials, 60
- hidden variables, 62, 73
- Hidden variables, 73
- Higgs boson, 92, 106, 113, 114, 119, 124, 125
- Higgs Bosons, 83, 107, 112
- Higgs coupling, 120, 121
- Higgs field, 5, 88, 101, 107, 113, 114, 117, 119, 120, 121, 135
- Higgs Field, 8, 83, 112, 116, 119, 120, 121
- Higgs mechanism, 97, 119, 136, 137, 138, 139, 140
- Higgs Mechanism, 83, 106, 107, 120, 140
- holes, 4, 15, 20, 71, 72, 80, 129, 131, 143
- Hubble constant, 12
- Hubble parameter, 2
- Hubble's Law, 12
- hydrogen binding, 132

- hydrogen bonding, 132
- Hydrogen bonds, 132, 133
- hydrogen energy, 132
- hypercharge, 87
- ice, 132, 133, 134
- Iceberg, 133
- indeterminism, 73
- inertial frame of reference, 39, 40
- inertial mass, 38, 39
- inflationary epoch, 5, 6, 8, 10, 15, 62
- Inflationary Epoch, 126
- information technologies, 62
- intelligent life, 15
- interaction bosons, 91, 95, 97
- ionised atoms, 130
- isospin charge, 87
- jet stream, 26
- journey to Mars, 79
- Kepler's Law, 16
- Kinetic Energy, 37
- Klein-Gordon equation, 104
- Klein-Gordon equations, 101, 111
- Lagrangian, 111, 123
- Lagrangian, 63, 69, 101, 103, 104, 105, 106, 107, 111, 112, 113, 115, 121
- Lagrangian space, 63, 69
- Lagrangians, 105
- Lambda-Cold Dark Matter, 9, 126
- Langrangian, 101
- Laplace operator, 59, 104
- Laplacian, 111, 138
- Large Hadron Collider, 83, 88, 108
- Large Hadron Colliders, 101
- Large-scale cosmos, 126
- length contraction, 29, 37
- Lenz's law, 134
- leptons, 85, 86, 88, 108, 120
- Leptons, 83, 88, 98, 140
- lightening, 131
- Lightening, 129
- lightning, 26, 82
- LIGO, 15
- liquid, 128, 129, 130, 132, 133, 134
- local symmetries, 105
- London equation, 138, 139
- Lorentz factor, 28, 35, 111, 122
- Lorentz transformations, 30, 31
- lunar year, 40
- Magnesia, 81
- magnetic constant, 15
- Magnetic Levitation, 137
- magnetic susceptibility, 138
- Manisa, 81
- mass charge, 87, 115, 119, 124
- mass term, 97, 112, 113, 115, 116, 117, 121, 122
- Matryoshka, 101, 103, 134
- matter, 2, 3, 4, 5, 6, 8, 13, 16, 19, 26, 27, 35, 43, 46, 54, 59, 73, 76, 79, 81, 82, 83, 85, 86, 89, 92, 95, 97, 100, 101, 103, 117, 118, 122, 124, 128, 129, 130, 136, 142, 143, 144
- Maxwell electrodynamics, 118
- Maxwell-Boltzmann statistics, 58
- Maxwell-Boltzmann Statistics, 54
- mean free path, 134
- Meissner effect, 135, 137, 138
- melting, 133
- meson, 92, 93, 94
- mesons, 92, 93, 98, 126
- methodology, 74, 76, 107
- metric expansion, 9, 21, 126
- Metric expansion, 9
- metric growth, 9
- Mexican Hat, 111, 112, 120, 137, 138
- Mexican hat distribution, 139
- Michelson interferometer, 26
- Michelson-Morley experiment, 26
- Microscopic universe, 126
- microwave, 7, 13, 19, 52, 131, 134
- microwave energy, 134
- Milky Way, 3, 13, 16, 22

- mini black holes, 143
- minimum escape velocity, 141
- Minkowski diagram, 10, 11
- momentum, 7, 24, 35, 36, 37, 47, 59, 60, 62, 63, 64, 65, 66, 70, 71, 75, 86, 111, 135
- nano-science and technology, 67
- NASA, 5, 13, 14, 45, 127
- naturally entangled systems, 61
- neutron, 84, 92, 94, 95, 98
- neutrons, 5, 8, 19, 83, 93, 94, 95, 96, 98, 122, 126, 128, 136, 140
- Neutrons, 92, 96, 98, 140
- Newton mechanics, 26, 58, 60, 63, 64
- Newton's classical gravity, 37
- Newton's Gravitation Law, 81
- Nobel Prize, 15, 83, 110
- non-Euclidian triangle, 34
- Non-simultaneity, 26
- normal conductivity, 134, 135
- normal matter, 3
- nuclear energy, 8, 93
- Nuclear force, 84
- nuclear fusion, 95, 126, 131
- Nuclear Physics, 84
- nuclei, 83, 86, 91, 93, 94, 95, 96, 97, 98, 106, 114, 118, 126
- nucleon, 84, 94
- nucleons, 54, 84, 92, 94, 95, 96, 97, 98, 118
- nucleus, 83, 84, 94, 95, 97, 104, 140
- objectivism, 76
- observable universe, 3, 9, 15, 54, 101
- Observable Universe, 2
- ontology, 74
- open universe, 19
- orbital, 60
- paradigms, 64, 74, 76, 79, 80, 81
- parity, 95, 96
- parity change, 95
- particle-antiparticle collisions, 88, 108
- particles, 2, 5, 7, 8, 18, 36, 37, 46, 47, 54, 59, 61, 71, 74, 76, 78, 79, 80, 83, 85, 86, 87, 90, 92, 93, 94, 95, 101, 104, 105, 107, 108, 109, 111, 114, 115, 117, 118, 119, 120, 122, 124, 126, 130, 136, 137
- Pauli exclusion principle, 61, 93, 94, 135
- Pauli Exclusion Principle, 93
- Pauli principle, 61, 117
- philosophy of critical realism, 76
- philosophy of science, 74, 76, 77
- Photon decoupling, 5, 126
- physical constants, 15
- Physical Constants, 155
- pion, 94, 95
- Planck constant, 7, 56, 59, 60, 62, 75, 96
- Planck epoch, 5, 7, 63
- Planck length, 2, 15
- Planck's constant, 2, 15, 62
- Planck's quantum theory, 56
- Planck's radiation law, 13, 14, 57
- plasma, 8, 13, 19, 48, 128, 130, 131, 140
- Plasma, 128, 129, 130, 131, 140
- PLUTO, 84
- p-n diode, 69
- position-momentum, 14, 62
- positivism, 73, 75, 76, 77
- positron, 94, 116, 117, 118, 119, 121
- post-positivism, 76
- Present Universe, 19
- Probability function, 60
- Propagation, 90, 115
- proper distance, 30
- protons, 5, 8, 13, 19, 83, 92, 93, 94, 95, 98, 122, 126, 140
- quantum biology, 62

- Quantum Chromodynamics, 93
- quantum computing, 62
- quantum confinement, 66, 91
- Quantum confinement, 66
- quantum dot, 66
- quantum electrodynamics, 118
- Quantum Electrodynamics, 82, 101, 105, 110
- Quantum entanglement, 61, 62
- quantum field, 4, 90, 116, 118, 120, 121
- Quantum Field Theory, 7, 79, 82, 101, 105
- quantum fields, 54, 73, 85, 97, 100, 101, 102, 103, 104, 105, 106, 107, 108, 111, 135
- quantum fluctuations, 5, 7, 12, 15, 62, 79, 100, 101, 103, 108, 126
- Quantum Fluctuations, 14
- quantum gravity, 80
- quantum lasers, 68
- quantum number, 67
- quantum numbers, 61, 93
- quantum particle, 90
- quantum physics, 58, 59, 61, 63, 68, 70, 74, 76, 107, 110
- Quantum Physics, 58
- quantum telepathy, 62
- quantum teleportation, 62
- quantum tunneling, 68, 69
- quantum well, 66
- quantum wire, 66
- quark matters, 128
- quark model, 92, 93
- quarks, 5, 8, 84, 85, 86, 88, 92, 93, 94, 95, 97, 98, 108, 120
- Quintessence, 18, 125
- radio astronomy, 12
- Ray bending, 40
- Rayleigh-Jeans Law, 55
- recombination era, 13
- red shifted frequency, 35
- redshift, 12, 13, 15
- Relativistic Doppler effect, 34
- Relativistic energy, 36
- relativistic football, 23, 31
- relativistic Harmonic oscillator, 111
- Relativistic mass, 35, 36
- Relativistic Mass, 122
- relativistic momentum, 35
- relativistic speeds, 28, 30, 31, 32, 35, 37
- Relativity of length, 29
- Relativity of time, 27, 28
- residual strong force, 94
- residual strong nuclear force, 94
- Ricci tensor, 47
- Rydberg constant, 16
- Ryleigh-Jeans Model, 55, 58
- scalar boson, 18, 88, 92, 106, 112, 113, 114, 121
- scale factor, 12, 19
- Schrödinger equation, 60, 67, 71, 103, 104, 139
- Schrödinger equations, 60, 101
- Schwarzschild radius, 141
- second law of thermodynamics, 2, 6, 7, 21, 126, 144
- semiconductor devices, 72
- Semiconductors, 71
- simple harmonic oscillator, 60
- Slater determinant, 61
- solar eclipse, 43, 44
- solid, 128, 129, 130, 132, 134, 136
- Space time bending, 42
- space-time, 9, 10, 11, 15, 16, 21, 28, 34, 37, 41, 42, 45, 46, 47, 48, 51, 54, 62, 75, 80, 81, 90, 97, 104, 105, 111, 114, 119, 121, 125, 126, 128, 140
- space-time curving, 37, 46, 47
- space-time metric, 47
- special relativity, 26, 27, 28, 31, 34, 35, 36, 37, 41, 42, 45, 46, 53, 62, 80, 81
- Special relativity, 27

- special symmetry, 23, 24, 26, 27, 28, 31, 34, 35, 36, 37, 41, 42, 45, 46, 53, 58, 62, 79, 80, 81, 106, 113
- Spectral distribution of black body radiation, 55
- speed of light, 2, 9, 10, 15, 23, 24, 26, 27, 35, 36, 39, 40, 47, 48, 61, 81, 91, 92, 104, 114, 124, 125
- spherical distribution, 91
- spin-orbit interactions, 60
- spontaneous symmetry breaking, 101, 103, 112, 113, 115, 119, 120, 121, 122, 137
- Spontaneous Symmetry Breaking, 107
- stages of creation, 5
- staller mass black holes, 143
- Standard Cosmology, 2, 8
- Standard Model, 18, 81, 85, 105, 106, 107, 108, 110, 111, 112, 113, 115, 121, 123, 126, 140
- Standard Theory, 80, 101
- strong charge, 87
- strong forces, 99
- strong interaction, 93, 94, 95, 96, 118
- strong nuclear force, 94
- strong nuclear interaction, 87, 92, 98, 126
- subatomic particles, 19, 84
- subjectivism, 76
- sublimation, 134
- superconducting phase, 134
- superconductivity, 92, 106, 117, 129, 134, 135, 137, 139, 140
- Superconductivity, 134, 137, 140
- Super-cooling, 126
- superdeterminism, 73, 75
- super-diamagnetism, 138
- Super-fluidity, 137
- superinsulation, 137
- supermassive black holes, 143
- supernova, 15
- symmetry, 8, 28, 83, 85, 88, 89, 96, 97, 100, 101, 103, 104, 105, 106, 107, 111, 112, 113, 114, 115, 117, 119, 120, 121, 122, 123, 126, 135, 137, 139
- symmetry breaking mechanisms, 97
- Symmetry breaking process, 92
- symmetry breaking transformations, 101
- symmetry groups, 98, 105, 106, 107, 111
- Symmetry groups, 105
- synchronicity principal, 64
- temperature gradient, 57
- tensor boson, 85, 88, 92
- tensor bosons, 91
- tesseract, 50
- the energy-momentum tensor, 47
- Theory of Everything, 79, 102, 108
- thermal radiation, 5, 13, 54, 55, 56, 58, 142, 143
- thermodynamic predictions, 122
- Thermodynamic predictions, 143
- these hadrons, 92, 93
- third law of thermodynamics, 143
- third-generation boson, 89
- togetherness principal, 64
- total eclipse, 43
- trench, 50
- Tunnelling, 68
- twin paradox, 28
- uncertainty principle, 63, 64, 67, 75, 108, 113, 118
- unitary symmetry, 104, 105, 106, 124
- universal constants, 2, 15, 118
- universal law of gravitation, 37
- vacuum dielectric constant, 118
- Vacuum polarization, 117
- valence bands, 71, 72
- vapour, 130, 131, 132
- vector bosons, 85, 88, 91, 104

- vector potential, 139
- velocity of light, 141
- very early universe, 18
- Virgo, 15
- virtual gravitons, 125
- virtual particle, 113, 118
- virtual particles, 7, 18, 114, 116, 118
- virtual photon, 117, 119, 123, 124
- virtual photons, 97, 115, 116, 124, 125
- virtual pion, 95
- W^+ , W^- and Z^0 bosons, 83
- water, 57, 79, 80, 129, 132, 133, 134
- wave mechanics, 60, 103
- waveform, 59
- wave-particle dilemma, 58, 59
- weak fields, 86
- weak interaction, 82, 92, 94, 95, 96, 97, 114, 118
- Weak interaction, 94, 95, 96
- weak interactions, 94
- weight, 38, 136, 143
- X-ray, 59
- Zener diode, 68
- Zener tunneling, 68
- zero mass, 46, 123
- zero-point energy, 70
- π -meson, 94

TABLE OF PHYSICAL CONSTANTS¹

Electron rest mass	m_e	9.109×10^{-31} kg
Proton rest mass	M_p	1.6726×10^{-27} kg
Electronic charge	e	1.6022×10^{-19} C
Speed of light in free space	c	2.9979×10^8 m s ⁻¹
Permeability of free space	μ_0	$4\pi \times 10^{-7}$ H m ⁻¹
Permittivity of free space	ϵ_0	8.854×10^{-12} F m ⁻¹
Planck's constant	h	6.626×10^{-34} J s
Reduced Planck's constant	$\hbar = h/2\pi$	1.0546×10^{-34} J s
	$\hbar c$	197.33 MeV fm
Boltzmann's constant	k_B	1.3807×10^{-23} J K ⁻¹
Gas constant	$\mathcal{R} = k_B/m_H$	8.250×10^3 J kg ⁻¹ K ⁻¹
Molar gas constant	R	8.315 J mol ⁻¹ K ⁻¹
Avogadro's number	N_A	6.022×10^{23} mol ⁻¹
Standard molar volume		22.414×10^{-3} m ³ mol ⁻¹
Unified atomic mass unit (¹² C scale)	u	931.5 MeV/c ² = 1.660538×10^{-27} kg
Mass of hydrogen atom	m_H	$1.0078u = 1.6735 \times 10^{-27}$ kg
Bohr magneton	μ_B	9.274×10^{-24} A m ² or J T ⁻¹
Nuclear magneton	μ_N	5.051×10^{-27} A m ² or J T ⁻¹
Proton magnetic moment	μ_p	$2.7928\mu_N$
Neutron magnetic moment	μ_n	$-1.9130\mu_N$
Bohr radius	a_0	5.292×10^{-11} m
Fine structure constant	$\alpha = e^2/(4\pi\epsilon_0\hbar c)$	$(137.04)^{-1}$
Compton wavelength of electron	$\lambda_C = h/(m_e c)$	2.4263×10^{-12} m
Rydberg's constant	R_∞	1.0974×10^7 m ⁻¹
	$R_\infty \hbar c$	13.606 eV
Stefan-Boltzmann constant	σ	5.671×10^{-8} W m ⁻² K ⁻⁴
Radiation density constant	$a = 4\sigma/c$	7.561×10^{-16} J m ⁻³ K ⁻⁴
Gravitational constant	G	6.673×10^{-11} N m ² kg ⁻²

¹ Revised in 2008 by University of Sussex.